

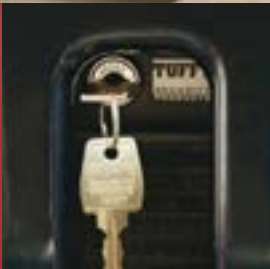

*SERIOUS THEFT
PROTECTION*



CATALOG #31

CONSOLES | GLOVE BOXES | LOCK BOXES | SECURITY DRAWERS | SPEAKER & WHEEL WELL STORAGE | TRUCK BED SECURITY | UNDER SEAT SECURITY



SERIOUS THEFT PROTECTION

| | | | |
|--------------------------------|-------|------------------------------------|-------|
| TRUCK SECURITY CONSOLE INSERTS | 4-6 | JEEP DECK ENCLOSURES | 32-33 |
| TRUCK UNDER SEAT LOCK BOXES | 7-11 | JEEP TAILGATE ENCLOSURES | 34-36 |
| COBBY COVERS | 13 | CARGO SECURITY | 37 |
| SECURITY DRAWERS | 13-19 | TUFFY FLIP-UP LICENSE PLATE HOLDER | 38 |
| UNIVERSAL CENTER CONSOLES | 20-21 | DOOR & HOOD LOCKERS | 38-39 |
| JEEP & FJ CENTER CONSOLES | 22-26 | TRUCK & SUV TACTICAL GEAR DRAWERS | 40-41 |
| OVERHEAD CONSOLES | 27 | TACTICAL SECURITY LOCK BOXES | 42 |
| GLOVE BOXES | 28-29 | PORTABLE SECURITY | 43 |
| JK FLIP-N-LOCK STEREO COVER | 30 | UNIVERSAL LOCK BOXES | 44 |
| SPEAKER SECURITY | 30-31 | ACCESSORIES | 45-46 |



WHAT MAKES TUFFY A SUPERIOR PRODUCT?

HIGHER SECURITY PUSH-LOCK LATCHING SYSTEM

PATENTED ANTI-TWIST PUSH BUTTON DESIGN

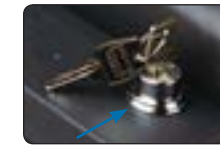

Patented Anti-twist lock design. If a product is locked, the push-button can still be pushed without de-activating the latch. Tuffy's anti-twist feature overcomes a major vulnerability of typical push button locks while keeping it convenient to use. Patent number 6564602.

PATENTED LATCH MECHANISM



This allows the box to latch shut without being locked. The patented Heavy duty latch mechanism features 1/4" thick and 1/8" thick metal components. It offers tremendous strength compared to other latches constructed with thinner gauge components or weak hook catches. Patent number 7140649.

TUFFY'S NEW HIGH SECURITY KEY

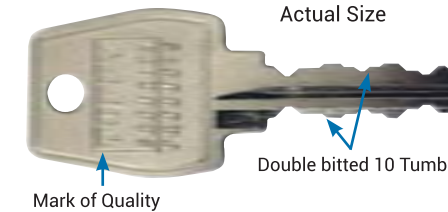

Tuffy's pick resistant lock offers security similar to the vehicles original ignition key. Other products using tubular keys can be broken into by simply punching out the center pin. Products with inexpensive, 5 tumbler, single bitted flat keys are easily picked.

TWO POINT WELDED STRIKER

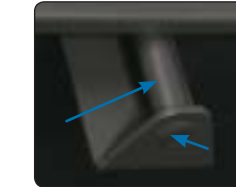

The Steel Striker is welded with a 2 point 1/2" solid steel pin. Other manufacturers cut corners and compromise security by fastening the striker with weak hardware and only connecting the pin on one side.

HIGHER SECURITY CAM-LOCK SYSTEM



SUPERIOR ENGINEERING FOR ADDED SECURITY (PATENT RIGHTS RESERVED)

Cam-lock security is provided by a dead bolt hooking effect which eliminates the force applied to the actual cam-lock components. Others try to imitate with a look alike, but only Tuffy's exclusive Pry-Guard system incorporates all the critical components.



Featuring a high security Cam-lock with a 10 Tumbler Double Bitted Key. Incorporating a large mounting shaft for increased strength.

HEAVIER DUTY DESIGN TO LAST A LIFETIME



HINGE DESIGN

Custom steel hinges are welded or bolted, not riveted, with Stainless Steel and 16 gauge Carbon Steel components. Featuring special Pin-Lock security.



WEATHER PROTECTION

Protection includes a specially formed and welded lid design incorporating neoprene weather seal, lock dust cover, and internal "O" ring protection. In addition Tuffy products are powder coated, a process superior in every way to wet paint.



LID EDGES

Lid Edges are double thickness creating a 1/8" thick steel rim offering extra strength during a break-in attempt.



INCREASED WELD STRENGTH

Exclusive Weld-Lock Design featuring TIG & MIG welds make Tuffy's construction stronger than other products that only use MIG welds, cheap spot welds, or weak rivets.

TUFFY CONVENIENCE FEATURES AND DURABLE COATINGS

CONVENIENT FEATURES AND ACCESSORIES



Interior and exterior storage trays, extra locks to key alike, large 3 1/2" diameter drink holders lined with neoprene fingers for a snug fit, interior lights, and finger pull levers are just a few of the little things that add value and convenience to make Tuffy products the only choice.

DURABLE TEXTURED POWDER COAT FINISHES AVAILABLE

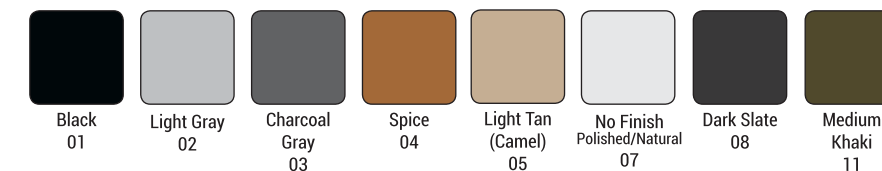

SUPERIOR DESIGN AND MANUFACTURING FROM TUFFY



MANUFACTURED AND DESIGNED IN THE USA

Tuffy products are manufactured by American employees at Tuffy's state-of-the-art facility located in Cortez, Colorado. This gives Tuffy the ability to closely monitor the production process, ensuring the customer always gets the best product on the market. This strict adherence to the highest quality standards enables Tuffy to back their products with an outstanding warranty, unsurpassed in the industry.

Tuffy's product designs are engineered and extensively field tested at Tuffy's facility by skilled developers with years of experience. Other "knock off" manufacturers skip the design process by stealing ideas from other companies, cheapen the product, and manufacture outside the US to maximize profit.

Cortez is nestled on the edge of the San Juan Mountains and the slick rock desert. Along with its local gems, Cortez has arguably the best trails in the world located within a 2 hour radius. (Moab, Telluride, Farmington, etc.) This location allows Tuffy employees to field test prototypes, constantly improve existing products through real world use, and develop new useful and unique products through a combination of personal use and collaboration with customers out on the trails.



Scan this code to browse our gear storage solutions online.

TUFFY – Concealed. Secure. Everywhere. Every Day.

visit TUFFYPRODUCTS.COM or call 800.348.8339 to order.

CHEVY SILVERADO SECURITY CONSOLE INSERT



Continuing the Tuffy legacy of designing and manufacturing the finest security console inserts in the industry since 1997, Tuffy is proud to introduce our security console insert for Chevy and GMC full size trucks. This 16 gauge steel console insert provides style, security and convenience. While maintaining the refined curves of the OEM console, the Tuffy console insert transforms your OEM console into a heavy-duty lockable storage area utilizing Tuffy's Pry-Guard locking system with 10 tumbler double bitted security key to help protect valuables from thieves. The Tuffy console insert provides access to optional OEM USB and power outlets from the console. The innovative design utilizes an exclusive lid support feature that keeps the lid open while accessing contents. The insert maintains a completely stock look including full use of armrest and lid. Featuring a durable texture powder coat finish, the insert comes ready to install in just a few minutes without drilling. Patent pending.



Tuffy exclusive lid support feature that keeps the lid open while accessing contents.

Integrated form fitting design provides access to OEM USB and power outlets from the console.

Quick and easy install, no drilling.



Maintains full use of the factory armrest and lid.

Exclusive 10 tumbler double bitted lock with built in weather seals and convenient finger pull.

Featuring Pry-Guard locking system with 1/8" thick welded steel components

Welded 16 Gauge steel construction. Durable texture powder coat finish.

Part #320 Color: Black - 01
Exterior Dimensions Overall: 8.950" L x 12.878" W x 8.723" H (9.511" H with finger pull)
Interior Storage Dimensions: Over 950 cubic inches.
Mounting: Installs in just a few minutes with hand tools, no drilling.

FITS:
Part 320: Chevy Silverado/GMC Sierra 2014-Current w/Flow-thru Console. (A flow-thru style console connects to the dash vs. a stand alone/jump seat console that does not.) (Requires removal of forward bin, and hanging folder supports.)

FORD F150 SECURITY CONSOLE INSERT



Continuing the Tuffy legacy of designing and manufacturing the finest security console inserts in the industry since 1997, Tuffy is proud to introduce our security console insert for the Ford F-150 flow-through center console. (A flow-thru style console connects to the dash vs. a stand alone/jump seat console that does not.) This 16 gauge steel console insert provides style, security and convenience. While maintaining the refined curves of the OEM console, the Tuffy console insert transforms your OEM console into a heavy-duty lockable storage area utilizing Tuffy's Pry-Guard locking system with 10 tumbler double bitted security key to help protect valuables from thieves. The Tuffy console insert provides access to optional OEM USB and power outlets inside the console utilizing an exclusive lid support feature that keeps the lid open while accessing contents. It maintains a completely stock look including full use of the factory accessory tray, armrest and lid. Featuring a durable texture powder coat finish, the insert comes ready to install in just a few minutes without drilling. Patent pending.



Tuffy exclusive lid support feature that keeps the lid open while accessing contents.

Provides access to optional OEM USB and power outlets inside the console.

Featuring Pry-Guard locking system with 1/8" thick welded steel components

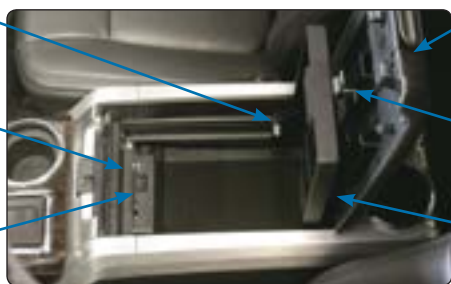

Maintains full use of the factory accessory tray, armrest and lid.

Exclusive 10 tumbler double bitted lock with built in weather seals.

Quick and easy install, no drilling
 Welded 16 Gauge steel construction
 Durable texture powder coat finish

Part #315 Color: Black - 01
Exterior Dimensions Overall: 12 1/8" L x 12" W x 8 1/2" H
Interior Storage Dimensions: Over 1,050 cubic inches.
Mounting: Installs in just a few minutes with hand tools, no drilling.

FITS:
Part 315: 2009-2014 Ford F150 flow-through center console.
Part 317: 2015-Current Ford F150 flow-through center console.
Part 334: 2009-2014 Ford F150 column shift with full floor center console.
 (A flow-thru style console connects to the dash vs. a stand alone/jump seat console that does not.)

FORD F250, F350, F450 SECURITY CONSOLE INSERT



Continuing the Tuffy legacy of designing and manufacturing the finest security console inserts in the industry since 1997, Tuffy is proud to introduce our security console insert for the Ford Super Duty 2011-2016 with a flow-through center console. (A flow-thru style console connects to the dash vs. a stand alone/jump seat console that does not.) This 16 gauge steel console insert provides style, security and convenience. While maintaining the refined curves of the OEM console, the Tuffy console insert transforms your OEM console into a heavy-duty lockable storage area utilizing Tuffy's Pry-Guard locking system with 10 tumbler double bitted security key to help protect valuables from thieves. The Tuffy console insert provides access to optional OEM power outlets in the console. The innovative design utilizes an exclusive lid support feature that keeps the lid open while accessing contents. The insert maintains a completely stock look including full use of the factory accessory rubber insert, armrest and lid. Featuring a durable texture powder coat finish, the insert comes ready to install in just a few minutes without drilling. Patent pending.



Patent rights reserved.

Tuffy exclusive lid support feature that keeps the lid open while accessing contents.

Includes external integrated accessory tray to keep convenience items within easy reach.

Provides cord access to optional OEM 12v power outlets from the console.

Quick and easy install, no drilling.

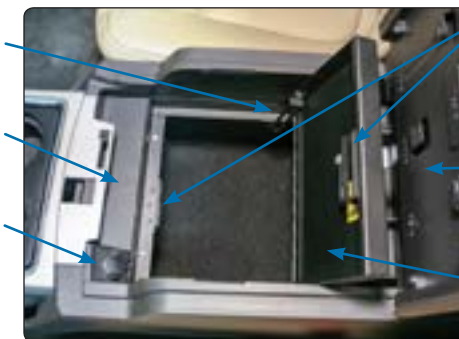

Featuring Pry-Guard locking system with 1/8" thick welded steel components. Exclusive 10 tumbler double bitted lock with built in weather seals.

Maintains full use of the factory accessory rubber insert, armrest and lid.

Welded 16 Gauge steel construction and durable texture powder coat finish.

Part #322 Color: Black - 01
Exterior Dimensions Overall: 16.280" L x 11.145" W x 8.793" H
Interior Storage Dimensions: Over 1,400 cubic inches.
Mounting: Installs in just a few minutes with hand tools, no drilling.

FITS:
 Ford F250 Super Duty 2011-2016 with a flow-through center console.
 Ford F350 Super Duty 2011-2016 with a flow-through center console.
 Ford F450 Super Duty 2011-2016 with a flow-through center console.
 Ford F550 Super Duty 2011-2016 with a flow-through center console.

RAM 1500, 2500, 3500 SECURITY CONSOLE INSERT



Continuing the Tuffy legacy of designing and manufacturing the finest security console inserts in the industry since 1997, Tuffy is proud to introduce our security console insert for RAM full size trucks. This 16 gauge steel console insert provides style, security and convenience. While maintaining the refined curves of the OEM console, the Tuffy console insert transforms your OEM console into a heavy-duty lockable storage area utilizing Tuffy's Pry-Guard locking system with 10 tumbler double bitted security key to help protect valuables from thieves. The innovative design utilizes an exclusive lid support feature that keeps the lid open while accessing contents. The insert maintains a completely stock look including full use of the factory armrest and lid. Featuring a durable texture powder coat finish, the insert comes ready to install. Drilling required for secure installation. Does not work with installed OEM remote CD player. Patent pending.



Tuffy exclusive lid support feature that keeps the lid open while accessing contents.

Featuring Pry-Guard locking system with 1/8" thick welded steel components.

Drilling required for secure installation.



Exclusive 10 tumbler double bitted lock with built in weather seals.

Includes external integrated accessory tray to keep convenience items within easy reach.

Maintains full use of the factory armrest and lid.

Welded 16 Gauge steel construction and durable texture powder coat finish.

Part #321 Color: Black - 01
Exterior Dimensions Overall: 9.054" L x 12.200" W x 5.481" H
Interior Storage Dimensions: Over 440 cubic inches.
Mounting: Simple install. Drilling required for secure installation.

FITS: Drilling required. Does not work with the installed OEM remote CD player.
 RAM 1500 Trucks 2010-Current with a fixed floor OEM console.
 RAM 2500 Trucks 2010-Current with a fixed floor OEM console.
 RAM 3500 Trucks 2010-Current with a fixed floor OEM console.

TOYOTA TUNDRA SECURITY CONSOLE INSERT



Continuing the Tuffy legacy of designing and manufacturing the finest security console inserts in the industry since 1997, Tuffy is proud to introduce our security console insert for the 2014-Current Toyota Tundra with a fixed center console. This 16 gauge steel console insert provides style, security and convenience. While maintaining the refined curves of the OEM console, the Tuffy console insert transforms your OEM console into a heavy-duty lockable storage area utilizing Tuffy's Pry-Guard locking system with 10 tumbler double bitted security key to help protect valuables from thieves. The Tuffy console insert provides access to optional OEM 12v power outlets from the console. The innovative design utilizes an exclusive lid support feature that keeps the lid open while accessing contents. The insert maintains a completely stock look including full use of armrest and lid. Featuring a durable texture powder coat finish, the insert comes ready to install in just a few minutes without drilling. Patent pending.



Part #323 Color: Black - 01
Exterior Dimensions Overall: 10.475" L x 11.434" W x 7.0" H (7.789" H with finger pull)
Interior Storage Dimensions: Over 900 cubic inches.
Mounting: Installs in just a few minutes with hand tools, no drilling.

FITS:
Part 323: Toyota Tundra 2014-Current with a fixed center console.

TOYOTA TACOMA SECURITY CONSOLE INSERT



Continuing the Tuffy legacy of designing and manufacturing the finest security console inserts in the industry since 1997, Tuffy is proud to introduce our security console insert for the Toyota Tacoma with a fixed center console. This 16 gauge steel console insert provides style, security and convenience. While maintaining the refined curves of the OEM console, the Tuffy console insert transforms your OEM console into a heavy-duty lockable storage area utilizing Tuffy's Pry-Guard locking system with 10 tumbler double bitted security key to help protect valuables from thieves. The innovative design utilizes an exclusive lid support feature that keeps the lid open while accessing contents. The insert maintains a completely stock look including full use of armrest and lid. Featuring a durable texture powder coat finish, the insert comes ready to install in just a few minutes without drilling. Patent pending.



Part 314 - Color: Black - 01
Exterior Dimensions Overall: 7.901" L x 10.421"W x 6.75"H
Interior Storage Dimensions: Over 340 cubic inches.
Mounting: Quick and easy install, no drilling.

FITS:
Part 314: Toyota Tacoma 2005-2015 with a fixed center console.
Part 324: Toyota Tacoma 2016-current with a fixed center console.

CHEVY SILVERADO CREW CAB UNDER REAR SEAT LOCK BOX

WORKS IN CHEVY SILVERADO AND GMC SIERRA CREW CAB TRUCKS



This high security 16 gauge steel security lockbox mounts under the rear seat in Chevy Silverado or GMC Sierra Crew Cab Trucks.

The full width formfitting design of the Tuffy lockbox has over 3500 cubic inches of lockable storage. It's secured contents are easily accessed by flipping either or both of the rear seat(s) up and opening the corresponding lid(s).

The unique design allows the full width to be used to stow firearms or other long items. Featuring Tuffy's Pry-Guard Locking System with a 10 tumbler double bitted security lock with built in weather seals.

Chamfered corners are incorporated into the design for easier passenger access.

The innovative mounting system is only accessed from inside the box. When additional floor space is needed the entire lockbox can be removed in seconds without the need for any tools.

Mounts inconspicuously under the seat out of apparent site of would be thieves. Is quickly and easily installed using the factory hardware without drilling.



This stealthy design has over 3500 cubic inches of lockable storage space that is hidden under the seat from prying eyes.

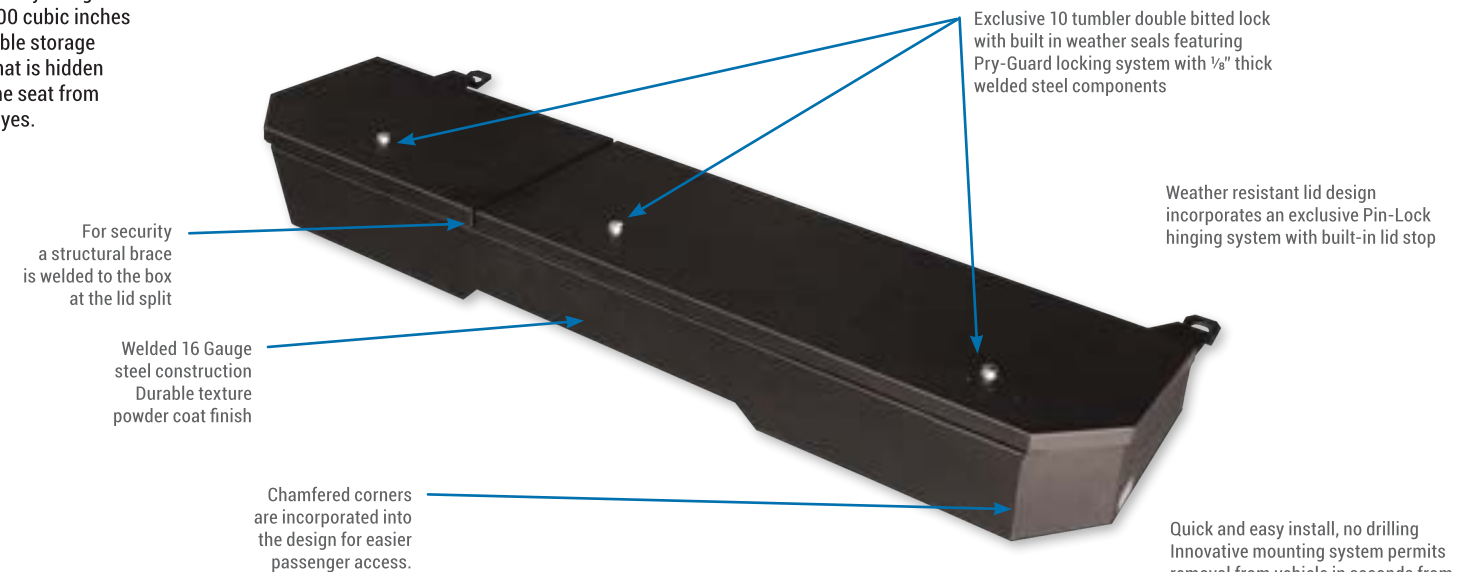

Part #307: Colors: Black - 01
Exterior Dimensions Overall: 13" L x 55 7/8" W x 7"-5" H (Height is tapered front to back)
Interior Dimensions: 12 3/8" L x 55 1/4" W x 5 1/2" - 3 5/8" H (Height is tapered front to back)
Lid Opening: 11" L x 35 1/8" W Large lid & 19 1/8" W Smaller lid
Mounting: No Drilling required. Fastens with original OEM hardware.
Optional Accessories: 082 3-Digit Combination Camlock

FITS:
 Chevy Silverado Crew Cab 2007 - Current
 GMC Sierra Crew Cabs (All chassis) 2007 - Current
 (Fits Crew Cab only and does not fit Double and Regular Cab)

FORD F150 2015+ UNDER REAR SEAT LOCK BOX

WORKS IN THE FORD F150 SUPERCREW & SUPERCAB CREW CAB TRUCKS



This high security 16 gauge steel security lockbox mounts under the rear seat in a 2015+ Ford F-150 SuperCrew Cab and 2017+ F-Series SuperCrew Cab. The full width formfitting design of the Tuffy lockbox has over 4500 cubic inches of lockable storage. It's secured contents are easily accessed by flipping either or both of the rear seat(s) up and opening the corresponding lid(s). The unique design allows the full width to be used to stow firearms or other long items. Featuring Tuffy's Pry-Guard Locking System with a 10 tumbler double bitted security lock with built in weather seals. Chamfered corners are incorporated into the design making it easier to operate the seat releases as well as aiding passenger ingress and egress. The innovative mounting system is only accessed from inside the box. When additional floor space is needed the entire lockbox can be removed in seconds without the need for any tools.

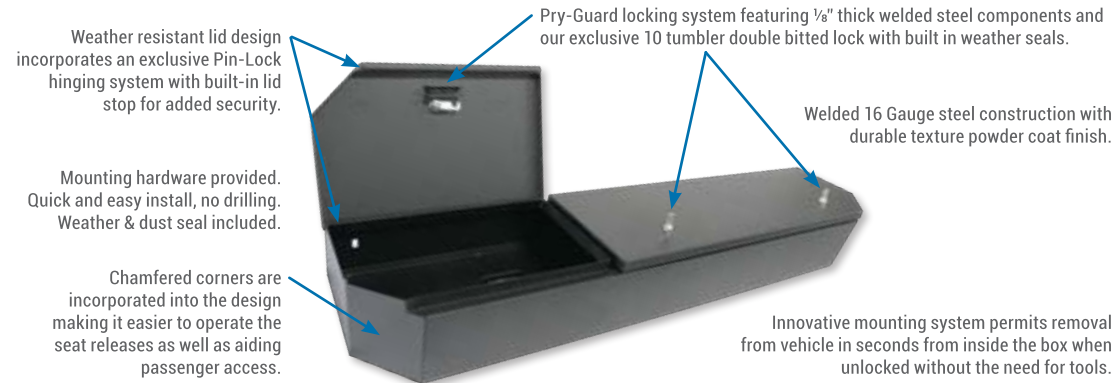

This stealthy design has over 4500 cubic inches of lockable storage space that mounts inconspicuously under the seat out of apparent site of would be thieves. Is quickly and easily installed using the factory hardware without drilling.

Part #316: Colors: Black - 01
Exterior Dimensions Overall: 56" w x 13" d x 8" h (front) - 6" h (back)
Interior Dimensions: 55 7/8" w x 12 7/8" d x 7 7/8" h (front) - 5 3/4" h (back)
Lid Opening: 36 1/2" x 10 7/8" - Large lid & 18 3/8" x 10 7/8" 18 5/8" x 10" Smaller lid
Mounting: No Drilling required. Fastens with original OEM hardware.

FITS:
 Ford F150 SuperCrew Crew Cab 2015+
 (will NOT fit with floor mounted Sony subwoofer option)

F150 CREW CAB UNDER REAR SEAT LOCK BOX (WITHOUT SUBWOOFER)



This high security 16 gauge steel security lock box mounts under the rear seat in an F-150 Crew Cab without the subwoofer. The full width formfitting design of the Tuffy lock box has over 4000 cubic inches of lockable storage. It's secured contents are easily accessed by flipping either or both of the rear seat(s) up and opening the corresponding lid(s). The unique design allows the full width to be used to stow firearms or other long items.

The innovative mounting system only accessed from inside the box when unlocked allows the entire lock box to be removed in seconds, without the need for any tools, when extra floor space is needed or to store the lock box and locked contents in an alternate location. Featuring Tuffy's Pry-Guard Locking System with a 10 tumbler double bitted security lock with built in weather seals. Mounts inconspicuously under the seat out of apparent site of would be thieves. Is quickly and easily installed using the factory hardware without drilling.



Part #283: Colors: Black - 01
Exterior Dimensions Overall: 14" L x 56" W x 7 3/8" H (Length and Height are tapered smaller)
Interior Dimensions: 13 3/4" L x 55 3/8" W x 6 7/8" H (Length and Height are tapered smaller)
Lid Opening: 11 7/8" L x 36 1/8" W Large lid & 18 1/8" W Smaller lid
Mounting: No Drilling required. Fastens with original OEM hardware.
Optional Accessories: 082 3-Digit Combination Camlock

FITS:
 Ford F-150 Crew Cab 2009 - 2014
 & Raptor Crew Cab
 without subwoofer or with subwoofer removed

F150 CREW CAB UNDER REAR SEAT LOCK BOX (WITH SUBWOOFER)



This high security 16 gauge steel lock box mounts under the rear seat (Driver side) in an F-150 Crew Cab with the subwoofer. The formfitting design of the Tuffy lock box has over 2740 cubic inches of lockable storage. It's secured contents are easily accessed by flipping the rear seat up.

The innovative mounting system only accessed from inside the box when unlocked allows the entire lock box to be removed in seconds, without the need for any tools, when extra floor space is needed or to store the lock box and locked contents in an alternate location. Featuring Tuffy's Pry-Guard Locking System with a 10 tumbler double bitted security lock with built in weather seals. Mounts inconspicuously under the seat out of apparent site of would be thieves. Is quickly and easily installed using the factory hardware without drilling.

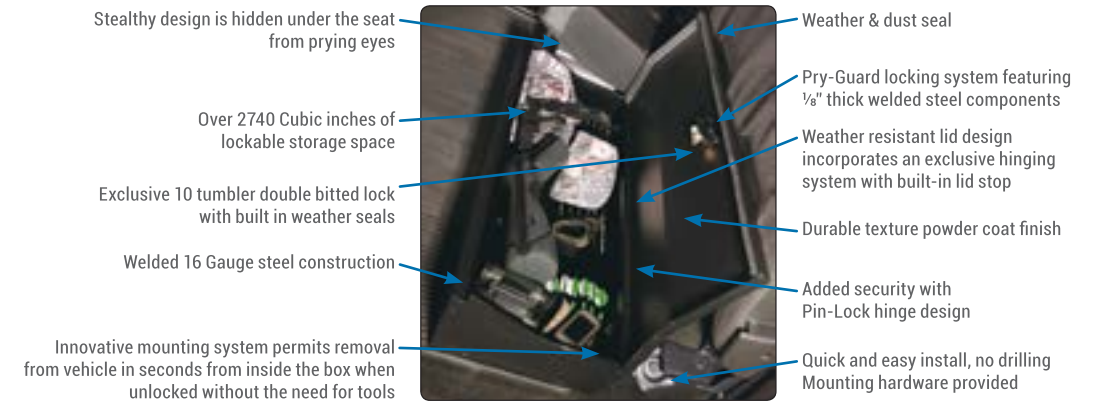

Part #287: Colors: Black - 01
Exterior Dimensions Overall: 14" L x 38 1/2" W x 7 3/8" H (Length and Height are tapered smaller)
Interior Dimensions: 13 3/4" L x 38" W x 6 7/8" H (Length and Height are tapered smaller)
Lid Opening: 11 7/8" L x 36 1/8" W
Mounting: No Drilling required. Fastens with original OEM hardware.
Optional Accessories: 082 3-Digit Combination Camlock

FITS:
 Ford F-150 Crew Cab 2009 - 2014
 & Raptor Crew Cab
 with or without subwoofer
 (Mounts under drivers side rear seat only)

F250/F350/F450 CREW CAB UNDER REAR SEAT LOCKBOX



This high security 16 gauge steel security lockbox mounts under the rear seat in a Ford F-250, 350 & 450 Crew Cab. The full width formfitting design of the Tuffy lockbox has over 2170 cubic inches of lockable storage. It's secured contents are easily accessed by flipping either or both of the rear seat(s) up and opening the corresponding lid(s). The unique design allows the full width to be used to stow firearms or other long items.

Featuring Tuffy's Pry-Guard Locking System with a 10 tumbler double bitted security lock with built in weather seals. Chamfered corners are incorporated into the design for easier passenger access. The innovative mounting system is only accessed from inside the box. Mounts inconspicuously under the seat out of apparent site of would be thieves. Is quickly and easily installed using the factory hardware without drilling.

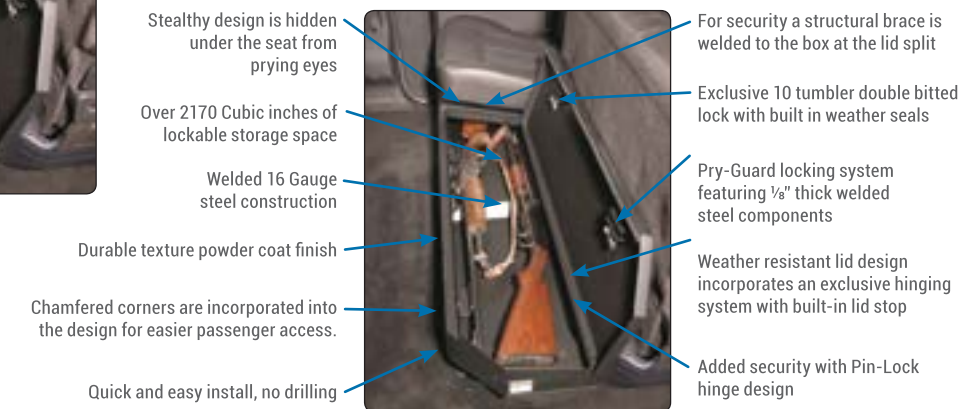

Part #309: Colors: Black - 01
Exterior Dimensions Overall: 58 1/16" x 11 1/4" x 6" -- 3 7/8" (tapered front to back)
Interior Dimensions: 57 7/16" x 11 1/8" x 5 3/8" -- 3 5/8" (tapered front to back)
Lid Opening: Large (37 3/4" x 9 1/4"), Small (18 5/8" x 9 1/4")
Mounting: No Drilling required. Fastens with original OEM hardware.

FITS:
 Ford F-250, 350 & 450 Crew Cab (4-door) 2003 - Current
 Requires removal of factory under-seat trays/boxes
 (Fits Crew Cab only and does not fit Super and Regular Cab)

FORD F150 X-CAB UNDER REAR SEAT LOCK BOX



This high security 16 gauge steel lock box mounts under the rear seat (Driver side) in an F-150 or Raptor Extended Cab with or without the subwoofer option. The formfitting design of the Tuffy lock box has over 2075 cubic inches of lockable storage.

Its secured contents are easily accessed by flipping the rear seat up. The unique design allows the OEM jack to still be mounted to the original bracket but additionally secured inside the lock box.

Featuring Tuffy's Pry-Guard Locking System with a 10 tumbler double bitted security lock with built in weather seals. Mounts inconspicuously under the seat out of apparent site of would be thieves. Is quickly and easily installed without drilling.

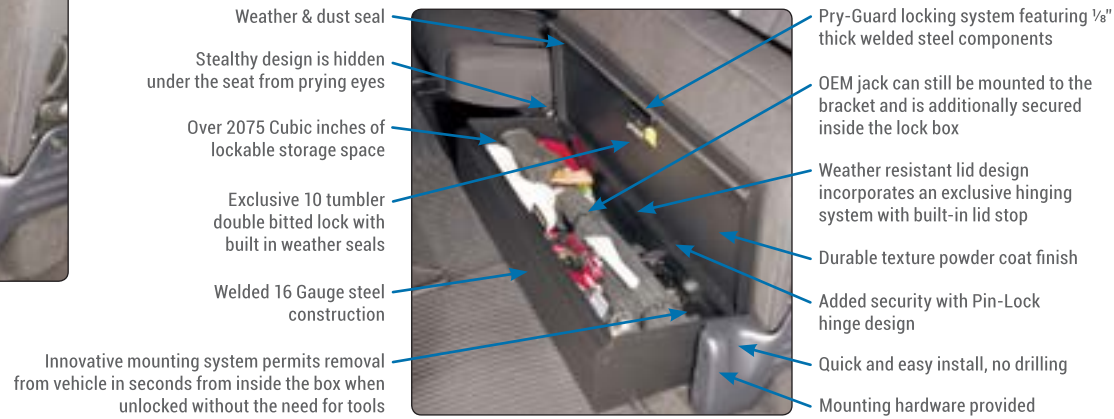

Part #285: Colors: Black - 01
Exterior Dimensions Overall: 11 1/4" L, 31 7/8" W, 7" H (Height is tapered smaller)
Interior Dimensions: 11 1/8" L, 31 3/8" W, 6 3/16" H (Height is tapered smaller)
Lid Opening: 9 3/16" L, 31 3/8" W
Mounting: No Drilling required. Fastens with original OEM hardware.
Optional Accessories: 082 3-Digit Combination Camlock

FITS:
Part #285: Ford F-150 Super Cab 2009-2014 & Raptor
Part #319: Ford F150 SuperCab 2015+
(will NOT fit with floor mounted Sony subwoofer option)
Part #319: Ford F250, F350, F450 SuperCab 2017+

2009-CURRENT RAM IN-FLOOR STORAGE SECURITY LID

WORKS IN THE CREW CAB AND QUAD CAB. DOES NOT WORK IN THE MEGA CAB.



This heavy duty locking In-floor Storage Security Lid replaces the existing plastic cover from the factory. Constructed from 16 gauge and 1/8" thick welded steel. It creates secure storage in the hidden floor compartment which is ideal for securing valuable tools and gear.

The unique design features our Pry-Guard locking system with 1/8" thick steel components and a welded continuous steel hinge. The lid also provides a sturdier and more durable deck surface for items placed on top. Easy to install using standard hand tools in just a few minutes.



Pry-Guard locking system with 1/8" steel components and a 10-tumbler, double bitted security lock containing built in weather seals

Continuous welded steel hinge Durable powder coat finish

Low profile-it's actually thinner than the OEM plastic solution.

Can be installed with or without the OEM Plastic Liner

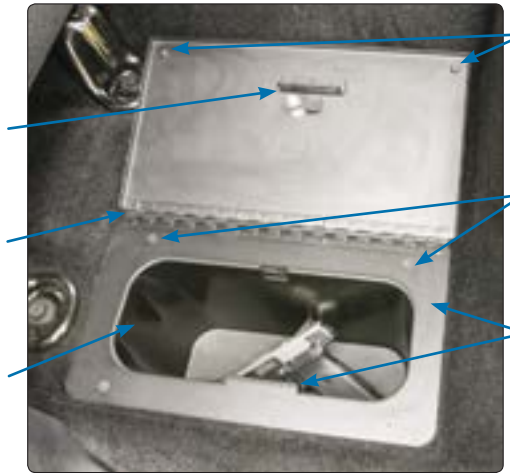

Multiple Bumpers to Reduce Rattling

Quick and Easy Installation - 4 screws mount the plate to the floor/no drilling

Steel Construction- 11 gauge Mount Plate with Integral Lock Bracket and 16 gauge flanged lid with all fastening hardware included

Part #311: Colors: Black - 01
Exterior Dimensions Overall: Approximately the same size as OEM cover
Interior Dimensions: Secures over 500 in³ of volume in storage area.
Mounting: No drilling required, mounts to original factory holes.
Optional Accessories: 091 Camlock Dust Cover

FITS:
 2009 - Current RAM 1500, 2500 & 3500 Crewcab and Quadcab.
 Does not fit the RAM Megacab.

TOYOTA TUNDRA UNDER REAR SEAT LOCKBOX

WORKS IN THE 2007-CURRENT TOYOTA TUNDRA DOUBLECAB



This high security 16 gauge steel security lockbox mounts under the rear seat in a Toyota Tundra DoubleCab. The full width formfitting design of the Tuffy lockbox has over 3200 cubic inches of lockable storage. It's secured contents are easily accessed by flipping either or both of the rear seat(s) up and opening the corresponding lid(s). The unique design allows the full width to be used to stow firearms or other long items.

Featuring Tuffy's Pry-Guard Locking System with a 10 tumbler double bitted security lock with built in weather seals. Chamfered corners are incorporated into the design making it easier to operate the seat releases as well as aiding passenger ingress and egress.

The innovative mounting system is only accessed from inside the box. When additional floor space is needed the entire lockbox can be removed in seconds without the need for any tools. Mounts inconspicuously under the seat out of apparent site of would be thieves. Is quickly and easily installed using the factory hardware without drilling.

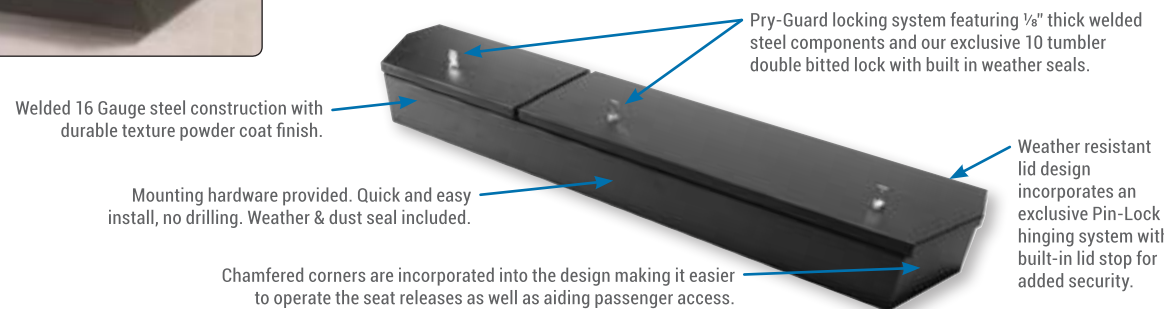

This stealthy design has over 3200 cubic inches of lockable storage space that is hidden under the seat from prying eyes. Innovative mounting system permits removal from vehicle in seconds from inside the box when unlocked without the need for tools.

Part #313: Colors: Black - 01
Exterior Dimensions Overall: 55 3/8"x12"x6 1/4"-5"
Interior Dimensions: 54 7/8"x 11 7/8" x 5 7/8" - 4 3/4"

Lid Opening: 31 3/4" x10" - Large lid & 18 5/8" x 10" Smaller lid
Mounting: No Drilling required. Fastens with original OEM hardware.

FITS:
 Toyota Tundra DoubleCab 2007-Current
(DOES NOT FIT IN THE CREWMAX)



2009-CURRENT RAM UNDER SEAT STORAGE SECURITY LID

WORKS IN THE CREW CAB AND QUAD CAB. DOES NOT WORK IN THE MEGA CAB.



This heavy duty locking Under Seat Storage Security Lid replaces the existing plastic OEM folding platform from the factory. Constructed from 16 gauge and 1/8" thick welded steel. It creates secure storage in the hidden seat compartment which is ideal for securing valuable tools and gear.

The unique design features our Pry-Guard locking system with 1/8" thick steel components and a welded continuous steel hinge. The lid also provides a sturdier and more durable deck surface for items placed on top. Easy to install using standard hand tools in just a few minutes.



Steel Construction- 16 gauge flanged lid

11 gauge mount plate with integral lock bracket with all fastening hardware included

Multiple Bumpers to Reduce Rattling

Durable powder coat finish



Pry-Guard locking system with 1/8" steel components and a 10-tumbler, double bitted security lock containing built in weather seals

Low profile-it's actually thinner than the factory plastic solution

Continuous welded steel hinge

Quick and Easy Installation - (No Drilling) No Permanent Vehicle Modifications. Mounting Points Secured Within Enclosure. Requires removal of OEM Folding Platform

Part #312: Colors: Black - 01
Exterior Dimensions Overall: 21" x 13 7/8" x 3 1/4"
Interior Dimensions: Secures over 600 in³ of volume in storage area.
Mounting: No drilling required, mounts to original factory holes.
Optional Accessories: 091 Camlock Dust Cover

FITS:
 2009 - Current RAM 1500, 2500 & 3500 Crewcab and Quadcab.
 Does not fit the RAM Megacab.

TOYOTA TACOMA BED SECURITY BOX



This 16 gauge steel security box replaces the plastic factory storage unit located in the Toyota Tacoma truck bed. The innovative design of the Tuffy replacement lockbox has 710 cubic inches of lockable storage which is over double what the original factory model has. It features Tuffy's exclusive Pry-Guard Locking System with a 10 tumbler double bitted security lock with built in weather seals. The design incorporates a continuous steel hinge, weather seal, welded construction, and a durable powder coated finish. This heavy duty lockbox bolts to the factory holes in the Toyota Tacoma truck bed without any drilling. Mounts standard on the left side of the Toyota Tacoma bed but can also be mounted on the right side on models that did not come equipped with the optional power outlet.

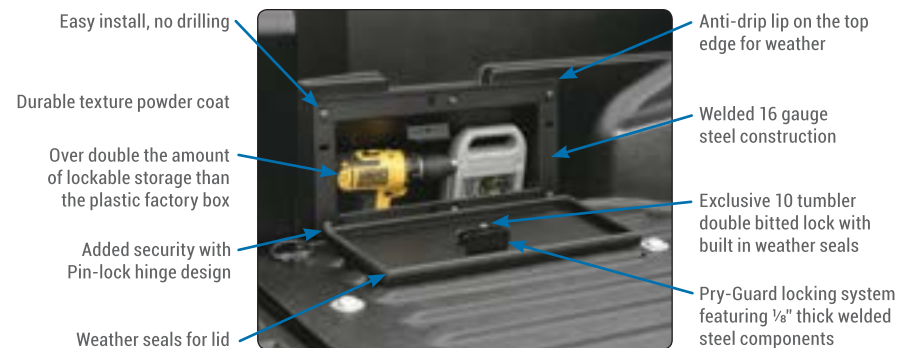

Part #161: Colors: Black - 01
Exterior Dimensions: 17 3/8"W x 13 1/2"H x 7 1/2"D
Interior Dimensions: Top angled section clearance is 4 1/8"H x 14 3/8"W x approx. 8"D, bottom vertical section clearance is 4 3/4"D x 14 3/8"W x approx. 6 3/4"H
Mounting: No drilling, mounts to original factory holes with OEM hardware.
Optional Accessories: 090 Finger Pull Lever | 091 Lock Dust Cover

FITS:
 Toyota Tacoma 2005 - Current
(mounts on the left side of the bed standard, can also be mounted on the right side on the models not equipped with the optional power outlet)

JK LOCKING CUBBY COVER



This heavy duty locking cubby cover replaces the existing flimsy cover from the factory. Constructed from 16 gauge and 1/8" thick welded steel. It creates secure storage in the hidden floor compartment which is ideal for securing valuable tools and gear. The unique design features our Pry-Guard locking system with 1/8" thick steel components and a welded continuous steel hinge. The lid also provides a sturdier and more durable deck surface for items placed on top.

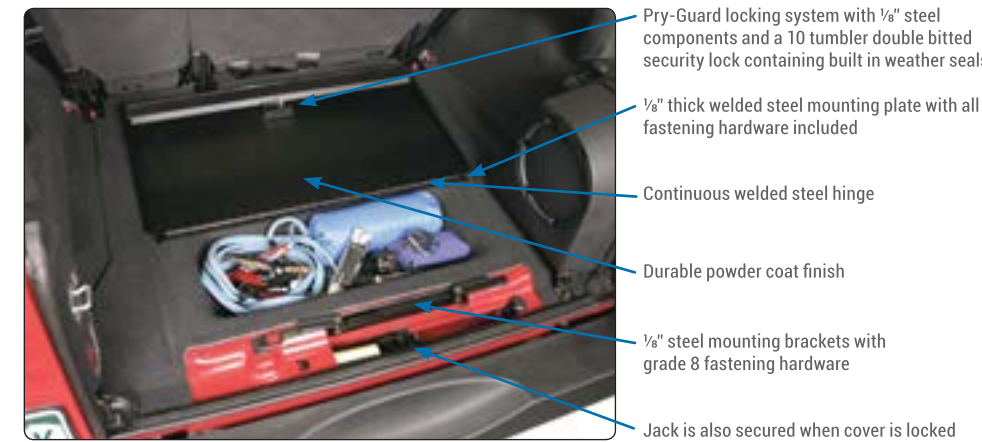

Part #143: Color: Black - 01
Exterior Dimensions: Approximately the same size as OEM cover
Interior Dimensions: Same amount of storage as OEM
Mounting: No drilling required, mounts to original factory holes. Will work in conjunction with Security Drawer #140.
Optional Accessories: 090 Interior Light | 091 Lock Dust Cover

FITS:
 Jeep Wrangler JK '07 - Current 2 & 4-Door

TOYOTA TACOMA SECURITY CUBBY COVER



This heavy duty locking security cubby cover covers the existing plastic OEM behind the rear seat cubby. Constructed from 16 gauge and 1/8" thick welded steel, it creates a secure storage area behind the Double Cab's rear seat, which is ideal for securing valuable tools and gear. The unique design features our Pry-Guard locking system with 1/8" thick steel components and a welded continuous steel hinge. The cover is easy to install using standard hand tools in just a few minutes. The cover allows the use of the OEM Child Seat retention point while the Security Cubby Cover is installed. A filler plate is provided for those individuals who do not choose to take advantage of this OEM feature.

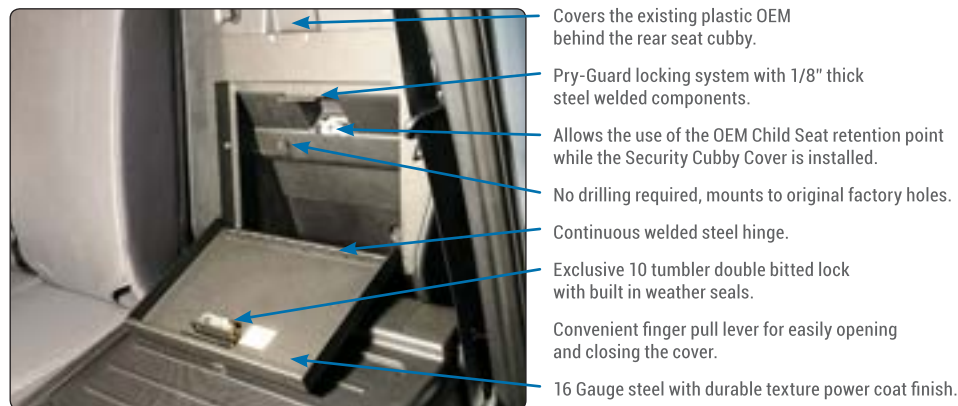

Part #331: Color: Black - 01
Lid Dimensions: 13.25"w x 9.5"h
Mounting: No drilling required, mounts to original factory holes.
Optional Accessories: 082 Combination 3-Digit Camlock

FITS:
 2005-Current Toyota Tacoma Double Cab.
(Does NOT fit Access or Regular Cabs)

SECURITY DRAWER - 2011+ FORD EXPLORER



This high security 16 gauge steel security drawer mounts under the drivers or passengers side seat in a 2011+ Ford Explorer. The formfitting design of the Tuffy lockbox has over 200 cubic inches of lockable storage with no need to reroute under seat wiring harnesses. Featuring Tuffy's Pry-Guard Locking System with a 10 tumbler double bitted security lock with built in weather seals. The design incorporates a heavy duty fully extending slide system, weather seal & welded construction. A formed rib in the enclosure additionally strengthens the locking system. Tuffy's exclusive bolt-blocker bracket is included for additional security. Mounts inconspicuously under the seat out of apparent site of would be thieves. Easily installs using the OEM factory hardware with no drilling required for standard installation. The drawer must remain locked while operating the vehicle. Manufactured by Tuffy in the USA.

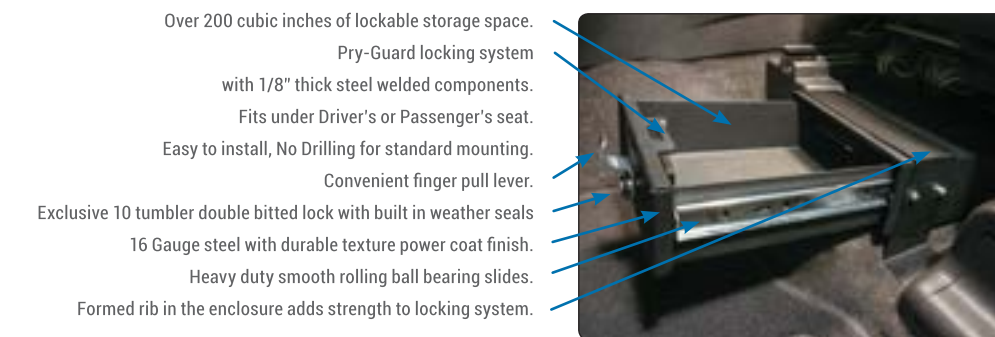

Part #: 335
Color: Black - 01
Exterior Dimensions Overall: 13.882"L, 18.040"W, 4.304"H
Interior Storage Dimensions: Over 200 cubic inches.

FITS:
 2011+ Ford Explorer and 2013+ Ford Police Interceptor SUV
Mounting:
 No Drilling required. Fastens with the two (2) OEM seat bolts.

JK CONCEAL CARRY DRIVER SIDE SECURITY DRAWER



This high security 16 gauge steel security drawer mounts under the drivers side seat in a Jeep JK. The formfitting design of the Tuffy lock box has over 324 cubic inches of lockable storage. Its secured contents are easily accessed by maneuvering the smooth ball bearing slides using the convenient pull lever.

Featuring Tuffy's Pry-Guard Locking System with a 10 tumbler double bitted security lock with built in weather seals. The design incorporates a heavy duty fully extending slide system, weather seal & welded construction. A formed rib in the enclosure additionally strengthens the locking system.

Mounts inconspicuously under the drivers side seat in a Jeep JK out of apparent sight of would be thieves. Uses the factory hardware without drilling. Optional security hardware is included which would require drilling one hole. The drawer must remain locked while operating the vehicle. Manufactured by Tuffy in the USA.

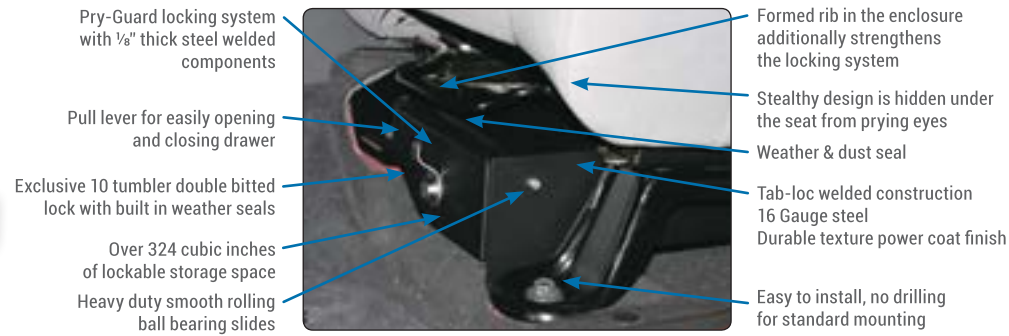

Part #247: Color: Black - 01
Exterior Dimensions: 17 3/8"L x 7 3/4"W x 3 3/4"H
Interior Dimensions: 17"L x 6 1/2"W (chamfered corner) x 3 5/16"H (chamfered corner)
Mounting: No drilling required for standard mounting. Fastens with original OEM hardware and include fasteners.
Optional Accessories: 082 Combo Lock

FITS:
 Jeep Wrangler JK '07 - '10 2-Door & 4-Door
 Jeep Wrangler JK '11 - Current 4-Door

TJ & LJ CONCEAL CARRY SECURITY DRAWER (NO FLIP SEAT)



This high security steel drawer mounts under the drivers side seat in a Jeep TJ & LJ (no flip seat). The formfitting design of the Tuffy lockbox has over 336 cubic inches of lockable storage. Its secured contents are easily accessed by maneuvering the drawer open and closed on the smooth ball bearing slides using the convenient pull lever.

Featuring Tuffy's Pry-Guard Locking system with a 10 tumbler double bitted security lock with built in weather seals. The design incorporates a heavy duty fully extending slide system, weather seal, and welded construction. A formed rib in the enclosure additionally strengthens the locking system.

Mounts inconspicuously under the drivers side seat in a Jeep TJ & LJ (no flip seat) out of sight of would be thieves. The drawer must remain locked while operating the vehicle.

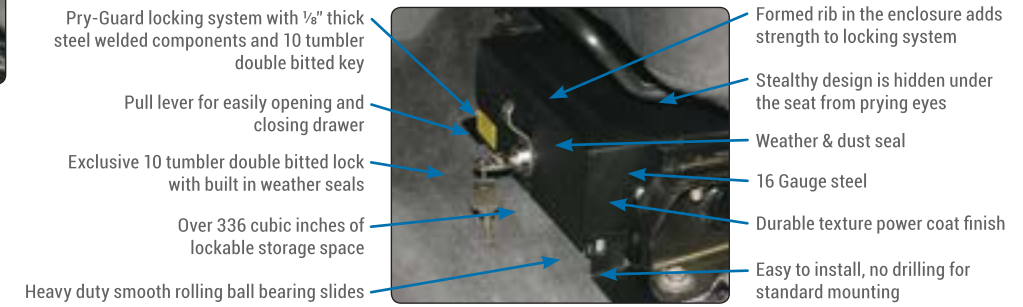

Part #248: Color: Black - 01
Exterior Dimensions: 17 1/4"L x 8 1/4"W x 3 3/16"H
Interior Dimensions: 16 13/16"L x 7"W x 2 7/8"H (2 1/16" clearance under latch bracket)
Mounting: No drilling required. Fastens with original OEM hardware and included fasteners.
Optional Accessories: 082 Combo Lock

FITS:
 Jeep Wrangler TJ '97 -'06 & LJ
(Fits vehicles where the drivers seat does not flip all the way up. These vehicles DO NOT HAVE the CAFS code on the Jeep build sheet: "Easy Access Driver Tip & Slide Seat" or "Easy Access Driver Seat")

JK CONCEAL CARRY PASSENGER SIDE SECURITY DRAWER



This high security 16 gauge steel security drawer mounts under the passenger side seat in a Jeep JK. The formfitting design of the Tuffy lockbox has over 324 cubic inches of lockable storage. Its secured contents are easily accessed by maneuvering the smooth ball bearing slides using the convenient pull lever.

Featuring Tuffy's Pry-Guard Locking System with a 10 tumbler double bitted security lock with built in weather seals. The design incorporates a heavy duty fully extending slide system, weather seal & welded construction. A formed rib in the enclosure additionally strengthens the locking system.

Mounts inconspicuously under the passenger side seat in a Jeep JK out of apparent sight of would be thieves. Uses the factory hardware without drilling. Optional security hardware is included which would require drilling one hole. The drawer must remain locked while operating the vehicle. Manufactured by Tuffy in the USA.

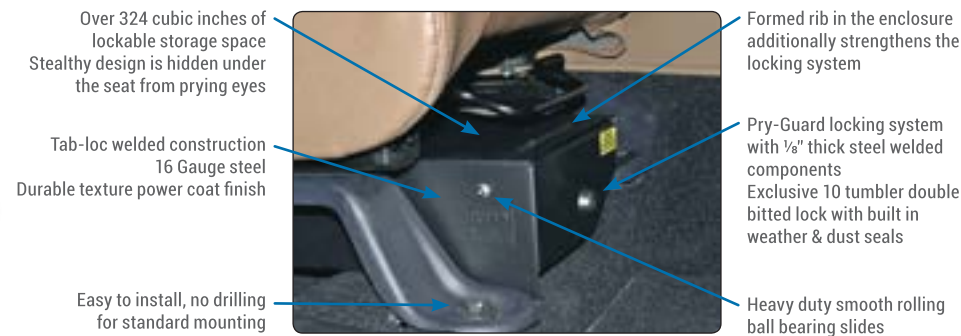

Part #293: Color: Black - 01
Exterior Dimensions: 17 3/8"L x 7 3/4"W x 3 3/4"H
Interior Dimensions: 17"L x 6 1/2"W (chamfered corner) x 3 5/16"H (chamfered corner) x 1 3/4"H
Mounting: No drilling required for standard mounting. Fastens with original OEM hardware and include fasteners.
Optional Accessories: 082 Combo Lock

FITS:
 Jeep Wrangler JK '07 - '10 2-Door & 4-Door
 (2 Doors w/o flip forward seat)
 Jeep Wrangler JK '11 - Current 4-Door

'97-'02 TJ CONCEAL CARRY SECURITY DRAWER (WITH FLIP SEAT)



This high security steel drawer mounts under the drivers side seat in a Jeep TJ (with flip seat). The formfitting design of the Tuffy lock box has over 149 cubic inches of lockable storage. Its secured contents are easily accessed by maneuvering the drawer open and closed on the smooth ball bearing slides using the convenient pull lever.

Featuring Tuffy's Pry-Guard Locking system with a 10 tumbler double bitted security lock with built in weather seals. The design incorporates a heavy duty fully extending slide system, weather seal, and welded construction. A formed rib in the enclosure additionally strengthens the locking system.

Mounts inconspicuously under the drivers side seat in a Jeep TJ (with flip seat) out of sight of would be thieves. The drawer must remain locked while operating the vehicle.

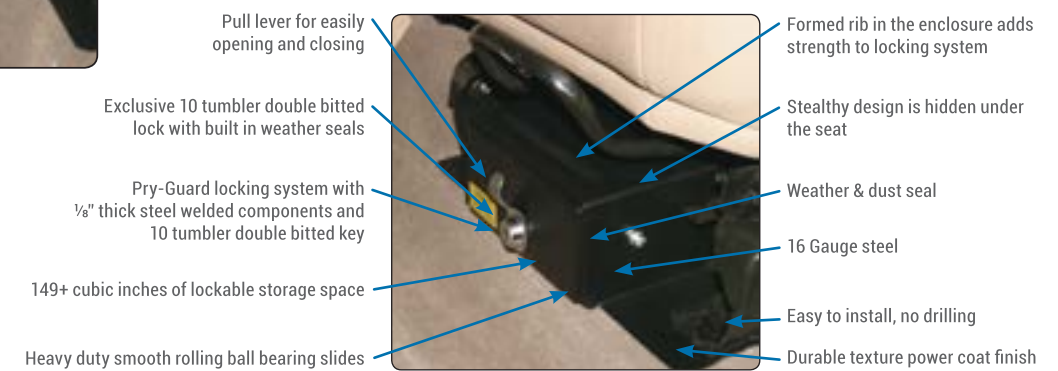

Part #250: Color: Black - 01 **Exterior Dimensions:** 12 13/16"L x 6"W x 3"H
Interior Dimensions: 12 3/8"L x 4 13/16"W x 2 1/2"H (1 13/16" clearance under latch bracket)
Mounting: No drilling required. Fastens with original OEM hardware and included fasteners.
Optional Accessories: 082 Combo Lock

FITS:
 Jeep Wrangler TJ '97 -'02
(Fits vehicles where the drivers seat flips all the way up. These vehicles HAVE the CAFS code on the Jeep build sheet: "Easy Access Driver Tip & Slide Seat" or "Easy Access Driver Seat")

TJ '03-'06 & LJ CONCEAL CARRY SECURITY DRAWER



This high security steel drawer mounts under the drivers side seat in a Jeep TJ & LJ (with flip seat). The formfitting design of the Tuffy lock box has over 128 cubic inches of lockable storage. Its secured contents are easily accessed by maneuvering the drawer open and closed on the smooth ball bearing slides using the convenient pull lever.

Featuring Tuffy's Pry-Guard Locking system with a 10 tumbler double bitted security lock with built in weather seals. The design incorporates a heavy duty fully extending slide system, weather seal, and welded construction. A formed rib in the enclosure additionally strengthens the locking system.

Mounts inconspicuously under the drivers side seat in a Jeep TJ & LJ (with flip seat) out of sight of would be thieves. The drawer must remain locked while operating the vehicle.



Tuffy's exclusive bolt-blocker bracket is included for additional security

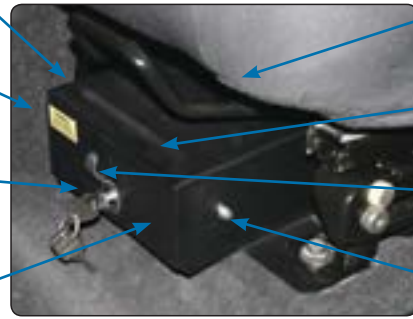

Weather & dust seal
Durable texture powder coat finish
Easy to install, no drilling

Pry-Guard locking system with 1/8" thick steel welded components and 10 tumbler double bitted key

Part #251: Color: Black - 01

Exterior Dimensions: 8 5/16" L x 7 3/16" W x 3 1/4" H

Interior Dimensions: 8 1/8" L x 6" W x 2 5/8" H (2 1/16" clearance under lock bracket)

Mounting: No drilling required. Fastens with original OEM hardware and include fasteners.

Stealthy design is hidden under the seat from prying eyes

Formed rib in the enclosure adds strength to locking system

Pull lever for easily opening and closing drawer

16 Gauge steel & Heavy duty smooth rolling ball bearing slides

FITS:

Jeep Wrangler TJ '03-'06 & LJ
(Fits vehicles where the drivers seat flips all the way up. These vehicles HAVE the CAFS code on the Jeep build sheet: "Easy Access Driver Tip & Slide Seat" or "Easy Access Driver Seat")

FORD TRANSIT CONNECT UNDER SEAT SECURITY DRAWER



UNIVERSAL MOUNTING, PERSONAL SECURITY

This high security 16 gauge steel security drawer mounts under the seat in any vehicle with sufficient space. The formfitting design of the Tuffy security drawer has over 433 cubic inches of lockable storage. It's secured contents are easily accessed by maneuvering the drawer open and closed on the smooth ball bearing slides.

Featuring Tuffy's Pry-Guard Locking System with a 10 tumbler double bitted security lock with built in weather seals. The design incorporates a heavy duty fully extending slide system, weather seal & welded construction. A convenient drop slot allows depositing receipts, business cards and other items into the drawer without compromising security. Mounts inconspicuously under the seat out of apparent sight of would-be thieves. Uses the factory hardware without drilling in most applications. The drawer must remain locked while operating the vehicle. Manufactured by Tuffy in the USA.

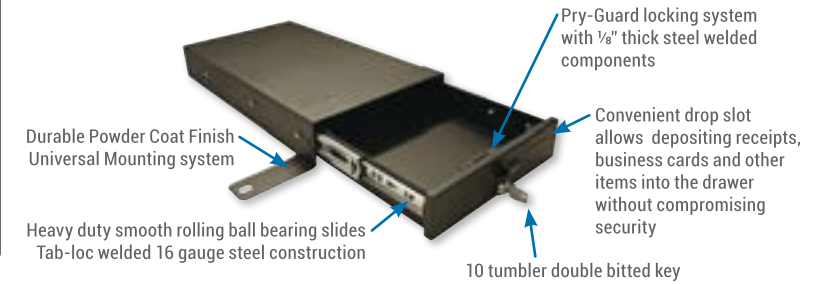
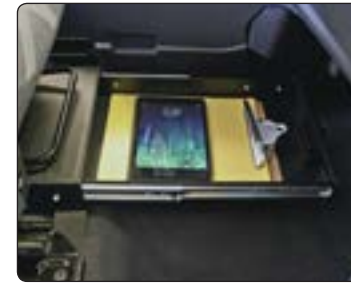
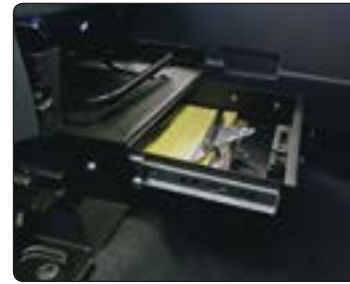

Durable Powder Coat Finish
Universal Mounting system

Heavy duty smooth rolling ball bearing slides
Tab-loc welded 16 gauge steel construction

Pry-Guard locking system with 1/8" thick steel welded components

Convenient drop slot allows depositing receipts, business cards and other items into the drawer without compromising security

10 tumbler double bitted key

Part #306: Colors: Black - 01

Exterior Dimensions: 20 1/4"L x 11 1/2"W x 3 1/4"H

Interior Storage Dimensions: 19 1/4"L x 10"W x 2 1/4"H.

Mounting: No drilling required. Fastens with original OEM hardware and include fasteners.

FITS:

Ford Transit Connect 2003 - 2013
Any vehicle with sufficient space and universal mounting bracket.

FORD BRONCO CONCEAL CARRY SECURITY DRAWER



This high security drawer mounts under the passenger's side seat in a '66 - '77 Ford Bronco. The formfitting design of the Tuffy lock box has over 439 cubic inches of lockable storage, as well as a side storage tray. Its secured contents are easily accessed by maneuvering the drawer open and closed on the smooth ball bearing slides using the convenient pull lever.

It mounts inconspicuously under the passenger's side seat in an early Ford Bronco out of apparent sight of would be thieves. Uses the factory hardware without drilling. The drawer must remain locked while operating the vehicle.



Side storage tray.
16 Gauge steel,
durable texture
powder coat finish

Easy to install,
no drilling for standard mounting

Weather & dust seal

Heavy duty smooth rolling ball bearing slides
Over 439 cubic inches of lockable storage space

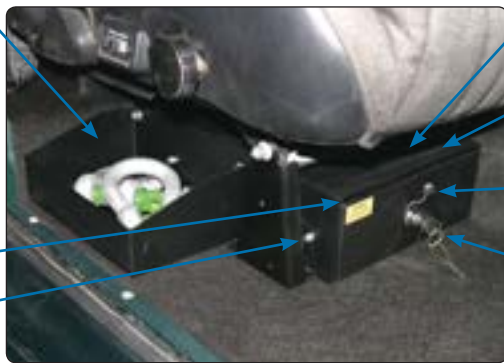

Stealthy design is hidden under the seat from prying eyes

Formed rib in the enclosure adds strength to locking system

Pull lever for easily opening and closing drawer

Pry-Guard locking system with 1/8" thick steel welded components and exclusive 10 tumbler double bitted lock with built in weather seals

FITS:

Ford Bronco '66 - '77 (with original seat and brackets OR original seat bracket mounting location)

Part #256: Color: Black - 01

Exterior Dimensions: 14 5/8"L x 9 1/4"W (17 1/4"W with mounting bracket) x 4 1/2"H

Interior Dimensions: 14 1/4"L x 8"W x 3 7/8"H Tray Dimensions: 6"L x 9"W x 3 1/4"H

Mounting: Mounts under passenger's side seat. No drilling required for standard installation. Fastens with original OEM hardware and included fasteners.

Optional Accessories: 082 Combo Lock

CONCEAL CARRY VALUABLES TOTE



Perfect for securing and transporting a handgun between the home, office and in a vehicle. The lockable welded steel storage box can be used to protect valuables both while carrying it by hand between locations and also inside a vehicle.

The included mounting sleeve is securely bolted to the vehicle or any sturdy mounting surface. The security box slides into the mounting sleeve and can be locked in place. The security box can additionally be removed from the sleeve and can remain locked closed during hand transport.

The system mounts anywhere there is available space and extra sleeves are available to allow the box to be secured in a sleeve mounted in the vehicle and also in the home or office.

The inside is lined with carpet to protect the contents. Optional pick-n-pluck foam is available for additional custom sized protection around the valuables. Models available feature either Tuffy's Pry-Guard locking system with a 10 tumbler double bitted key or a pushbutton combo lock for quick keyless access to contents (both are shown in some images).

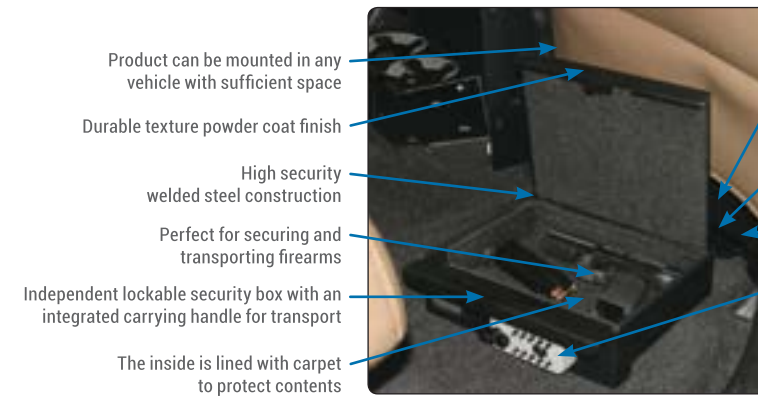

Product can be mounted in any vehicle with sufficient space

Durable texture powder coat finish

High security welded steel construction

Perfect for securing and transporting firearms

Independent lockable security box with an integrated carrying handle for transport

The inside is lined with carpet to protect contents

Mounting sleeve bolted to vehicle or a sturdy surface that can secure the lockable security box

Extra mounting sleeves available, one is included. (Part #289-MNT-01)

Mounting hardware provided

Models available feature either Tuffy's Pry-Guard locking system with a 10 tumbler double bitted key or a pushbutton combo lock for quick keyless access to contents



Part #289: Colors: Black - 01

Exterior Dimensions: 9"L x 10"W x 3"H **Interior Dimensions:** 6 3/8"L x 9 1/2"W x 2"H

Mounting: Mounts in any vehicle or sturdy surface with sufficient mounting space, drilling required.

Optional Accessories: 289-MNT-01 Extra Mounting Sleeve; 089-289 Pushbutton Combo Lock | 082-289 3-Digit Combination Camlock

FITS:

Any vehicle with sufficient space or structural mounting surface inside a home, shop or office.

FULL LENGTH UNDER SEAT DRAWER



A true space saver which utilizes the entire floor from under the front of the rear seat to the tailgate. This super secure, 16 gauge steel drawer provides a secure place to store valuables without losing the rear seat.

Space saving design and fully enclosed, Wrangler seat will still fold & tumble
Durable powder coat finish
Drawer pulls out the full length
2,520 cubic inches of storage space



Patented Pry-Guard II locking system with a 1/4" steel latch which enables the drawer to be latched closed without locking
Patented Anti-twist push button lock system with a 10 tumbler double bitted security key containing built in weather seals



Part #130: Full Length Drawer, Color: Black - 01

Exterior Dimensions: 29 1/8"L x 34 1/2"W x 4 1/8"H

Interior Dimensions: 28 1/8"L x 29 7/8"W x 3"H

Mounting: Mounting kit required, sold separately, see below

Optional Accessories: 864 Diamond Vinyl Mat | 860 Carpet Lining | 026, 038, 045, or 078 Mounting kit

FITS:

CJ-7 '76 - '86 (requires mounting kit #026)
Wrangler YJ '87 - '95 (requires mounting kit #045)
Wrangler TJ '97 - '02 (requires mounting kit #038)
Wrangler TJ '03 - '06 (requires mounting kit #078)

MOUNTING KITS FOR SECURITY DRAWER #130 (REQUIRES ORDERING DRAWER AND CORRESPONDING MOUNTING KIT)

Part #026 Mounting Kit: Color: 01

Fits: CJ-5 '76 - '83 & CJ-7 '76 - '86

Mounting: No drilling required. Mounts through the floor, seat mounts on top of the drawer, seat will be raised 3 1/2" - 3 7/8". Product is compatible with rear storage lockboxes #014 & #025.

Part #045 Mounting Kit: Color: 01

Fits: YJ Wrangler '87 - '95

Mounting: Some YJ models require minimal drilling. Mounts through the floor, seat mounts on top of the drawer, seat will be raised 3 1/2" - 3 7/8". Product is compatible with rear storage lockboxes #014 & #025.

Part #038 Mounting Kit: Color: 01

Fits: TJ Wrangler '97 - '02

Mounting: No drilling required. Mounts through the floor, seat mounts on top of the drawer, seat will be raised 3 1/2" - 3 7/8". This product is not compatible with rear storage lockbox #039.

Part #078 Mounting Kit: Color: 01

Fits: TJ Wrangler '03 - '06

Mounting: No drilling required. Mounts through the floor, seat mounts on top of the drawer, seat will be raised 3 1/2" - 3 7/8". This product is not compatible with rear storage lockbox #039.

REAR CARGO SECURITY DRAWER



This heavy duty, high security, 16 gauge steel drawer mounts in place of the rear seat in a Jeep Wrangler, CJ, or any other vehicle with sufficient space. The large drawer slides on heavy duty roller bearings and can be securely locked to provide protection for equipment and other valuables. Accessories are available for this product.

Durable powder coat finish
7,700 cubic inches of storage space
Roller bearing slides rated to 300# evenly distributed
Grade 8 mounting hardware provided
Divider kit sold separately



Weatherproof construction
Patented Pry-Guard II locking system with a 1/4" steel latch which enables the drawer to be latched closed without locking
Patented Anti-twist push button lock system with a 10 tumbler double bitted security key containing built in weather seals

Part #058: Drawer Color: Black - 01

Exterior Dimensions: 30"L x 35 3/8"W x 8"H

Interior Dimensions: 29 1/2"L x 28 1/2"W x 7"H

Mounting: Mounts through the floor of the vehicle, drilling required in some vehicles. Mounting brackets to raise drawer for storage underneath are sold separately on the next page

Optional Accessories: 059 3" Riser Kit | 072 1" Riser Kit | 060 Divider Kit | 158 Tie Down Rails | 159 Gear Anchors | 864 Diamond Vinyl Mat | 860 Carpet Lining

FITS:

Wrangler TJ '97 - '06
Wrangler YJ '87 - '95
CJ-7 '76 - '86
CJ-5 up to '83*
Cherokee XJ '84 - '01 (needs kit #072)
Bronco '66 - '96*
Blazer K5*
Land Cruiser FJ-40*
Defender 90 & 110*
Scout & Scout II*
Hummer*
* = Additional hardware may be required by customer

FJ SECURITY DRAWER



This heavy duty, high security, 16 gauge steel drawer mounts behind the rear seat in an FJ Cruiser. The large drawer slides on heavy duty roller bearings and can be securely locked. It provides protection for tools, gear, and other valuables. The drawer features an adjustable height mounting system which creates up to 4" of storage under the drawer. The side panels open to access the jack, power outlets, and additional storage. A divider kit is available but sold separately.



12,474 cubic inches of storage space
Durable powder coat finish
Mounting hardware included



Patented Anti-twist push button lock system with a 10 tumbler double bitted security key containing built in weather seals

Both side panels flip open for additional storage access
Drawer can be mounted with or without OEM sub woofer
Roller bearing slides rated to 300# evenly distributed
Divider kit sold separately
Patented Pry-Guard II locking system with a 1/4" steel latch which enables the drawer to be latched closed without locking

Part #145: Color: Black - 01, Drawer (Divider kit sold separately #141 below)

Exterior Dimensions: 56 3/4"L x 28 1/8"W x 13 1/2"H

Interior Dimensions: 32 7/8"L x 28"W x 12 1/4"H

Mounting: No drilling required, mounts to original factory holes.

Optional Accessories: 141 Divider Kit | 158 Tie Down Rails | 159 Gear Anchors | 864 Diamond Vinyl Mat | 860 Carpet Lining

FITS:

Toyota FJ Cruiser '07 - Current (With or without OEM factory sub woofer)

Accessory Divider Kit Part #141: Color: 07

Fits: #140 and #145

Included Parts: 2 full width dividers and 2 center dividers.

LJ UNLIMITED SECURITY DRAWER



This heavy duty, high security, 16 gauge steel drawer mounts behind the rear seat in a Jeep Unlimited LJ. The large drawer slides on heavy duty stainless steel roller bearings and can be securely locked to provide protection for equipment and other valuables. The drawer can be mounted at four different available heights with a maximum clearance of 4" underneath which creates an ideal spot to store more items. An optional divider kit is available for this drawer but must be ordered separately.

6,590 cubic inches of storage space
Roller bearing slides rated to 300# evenly distributed
Clearance height under drawer can be set to 4 different height settings
Divider kit sold separately
Durable powder coat finish

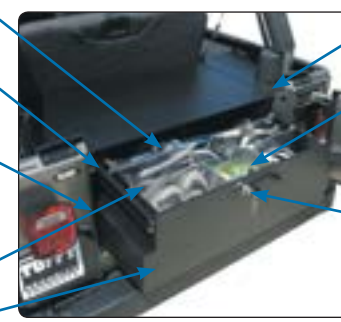

Weatherproof, fully welded construction
Patented Pry-Guard II locking system with a 1/4" steel latch which enables the drawer to be latched closed without locking
Patented Anti-twist push button lock system with a 10 tumbler double bitted security key containing built in weather seals

Part #131: Drawer Color: Black - 01, Drawer (Divider kit sold separately #133 below)

Exterior Dimensions: 20 1/8"L x Box 34 1/4"W, Overall 53 1/4"W x 11 3/4"H

Interior Dimensions: 19 7/8"L x Bottom 32 3/4"W, Top 27 3/4"W x 10 7/8"H

Mounting: Mounts through the floor of the vehicle and side walls. The drawer can be mounted at four different mounting heights with a 4" maximum clearance under the drawer.

Optional Accessories: 133 Divider Kit | 159 Gear Anchors | 864 Diamond Vinyl Mat | 860 Carpet Lining

FITS:

Unlimited LJ '04 - '06
TJ '97 - '06 (With back seat removed)

Accessory Divider Kit Part #133: Color: 07

Included Parts: (2) full width and (2) center dividers



DELUXE STEREO SECURITY CONSOLE



This 16 gauge steel security console has two compartments: a compartment for mounting a stereo, CB radio, or other electronic equipment; and a lockable rear storage compartment. The spacious rear compartment accommodates a CD changer, tools, and other valuables.

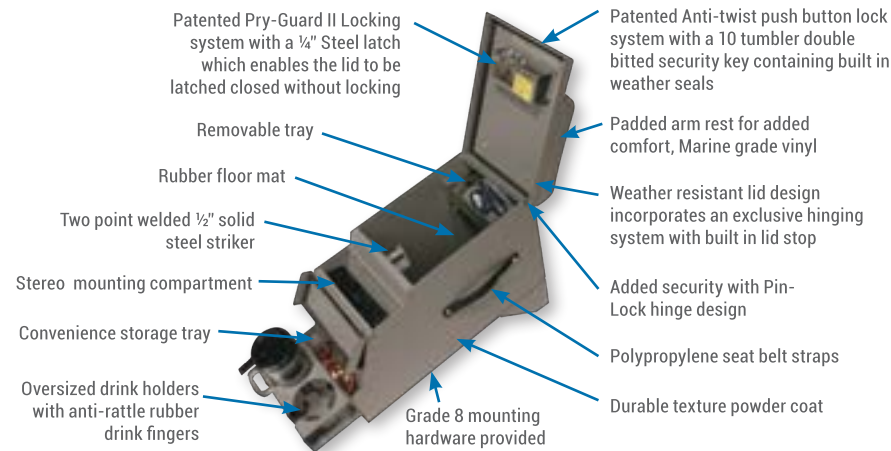

UNSURE OF THE SIZE YOU NEED?
Measure at the smallest distance between seats

SERIES II SECURITY CONSOLE



This 16 gauge steel security console features Tuffy's patented push button latch system. For safety and convenience while operating the vehicle, the lid latches closed without having to be locked. It has a spacious compartment for mounting a CD changer, storing tools, electronic equipment, cellular phones, and other valuables.

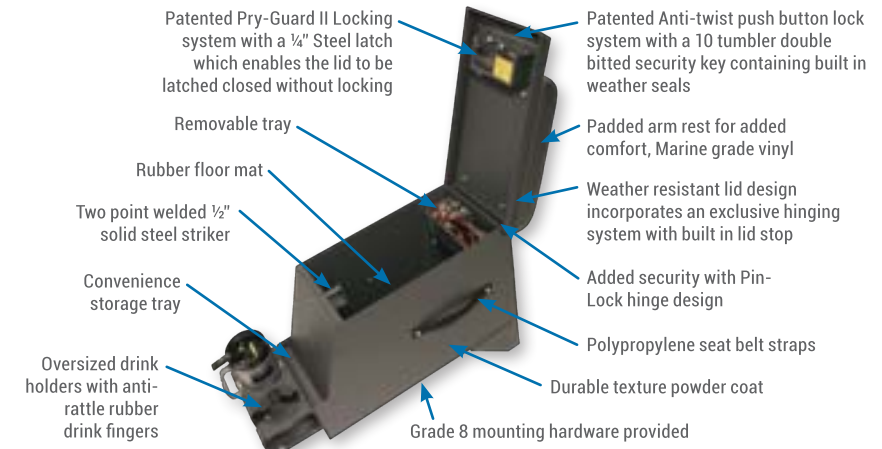

UNSURE OF THE SIZE YOU NEED?
Measure at the smallest distance between seats



Part #024: Colors: 01, 03
Exterior Dimensions: 24" L (includes cup holder) x 6 1/2" W (rear compartment) & 8" W (stereo compartment & cup holder) x 18 1/2" H (includes 4" mounting bracket), 3 1/2" holes for drinks
Interior Dimensions: 12" L (top) 16" L (bottom) x 6" W x 12" H
Stereo Compartment: (All sizes) Comes Pre-cut for DIN mount stereo 2 1/8" L x 7 1/4" W x 7" Depth, 67° Angle (Stereo not Included)

FITS:
Wrangler YJ '92 - '95
Toyota trucks with space**
Land Cruiser FJ-40 '64 - '72**
Land Cruiser FJ-40 '73 - '80*
*Mounting kit required, p. 23
Land Cruiser FJ-40 '81 - '84**
*Requires moving OEM heater
Other vehicles with space**



Part #013: Colors: 01, 03, 04
Exterior Dimensions: 24" L (includes cup holder) x 8" W x 18 1/2" H (includes 4" mounting bracket), 3 1/2" holes for drinks
Interior Dimensions: 12" L (top), 16" L (bottom) x 7 1/2" W x 12" H
Stereo Compartment: (All sizes) Comes Pre-cut for DIN mount stereo 2 1/8" L x 7 1/4" W x 7" Depth, 67° Angle (Stereo not Included)

FITS:
Wrangler YJ '91 - '95
CJ-5 up to '75**
Bronco '66 - '77*
*Mounting kit required, p. 23
Jeep SJ**
Toyota trucks with space**
Other vehicles with space**



Part #033: Colors: 01, 04
Exterior Dimensions: 24" L (includes cup holder) x 10" W x 18 1/2" H (includes 4" mounting bracket), 3 1/2" holes for drinks
Interior Dimensions: 12" L (top), 16" L (bottom) x 9 1/2" W x 12" H
Stereo Compartment: (All sizes) Comes Pre-cut for DIN mount stereo 2 1/8" L x 7 1/4" W x 7" Depth, 67° Angle (Stereo not Included)

FITS:
Wrangler YJ '87 - '90
CJ-7 '76 - '86
CJ-5 '76 - '83
Ford, Chevy & Dodge trucks with space**
Scout & Scout II
Utility van with space**
Other vehicles with space**



Part #017: Colors: 01, 03
Exterior Dimensions: 24" L (includes cup holder) x 12 1/2" W x 18 1/2" H (includes 4" mounting bracket), 3 1/2" holes for drinks
Interior Dimensions: 12" L (top), 16" L (bottom) x 12" W x 12" H
Stereo Compartment: (All sizes) Comes Pre-cut for DIN mount stereo 2 1/8" L x 7 1/4" W x 7" Depth, 67° Angle (Stereo not Included)

FITS:
Bronco '78 - '96
Ford, Chevy & Dodge trucks with space**
Utility van with space**
Blazer K5
Defender 90 up to '95*
*Mounting kit required, p. 23
Other vehicles with space**

Mounting: Mounts through floor, drilling required (3) holes.

* = Console requires a special mounting kit (See page 23)

** = Product will mount if sufficient space exists, additional hardware provided by customer or modifications to hardware may be required

Optional Accessories

| | | | |
|----------------------------------|-----------------------|-----------------------|----------------------|
| Mounting kits 057, 074, 076, 077 | 151 Stereo Dash Cover | 080 Finger Pull Lever | 862 12V Power Source |
| 150 Stereo Dash Tray | 034 Rear Drink Holder | 870 Auto on/off Light | 863 Gas Strut |



Part #023: Colors: 01, 03, 04
Exterior Dimensions: 24" L (includes cup holder) x 6 1/2" W (cup holder is 8" W) x 18 1/2" H (includes 4" mounting bracket) 3 1/2" holes for drinks
Interior Dimensions: 15 1/2" L (top), 20" L (bottom) x 6" W x 12" H

FITS:
Wrangler YJ '92 - '95
Toyota trucks with space**
Land Cruiser FJ-40 '64 - '72**
Land Cruiser FJ-40 '73 - '80*
Land Cruiser FJ-40 '81 - '84**
(Requires moving OEM heater)
Blazer S10
Other vehicles with space**



Part #012: Colors: 01, 03, 04
Exterior Dimensions: 24" L (includes cup holder) x 8" W x 18 1/2" H (includes 4" mounting bracket) 3 1/2" holes for drinks
Interior Dimensions: 15 1/2" L (top), 20" L (bottom) x 7 1/2" W x 12" H

FITS:
Wrangler YJ '91 - '95
CJ-5 up to '75**
Jeep SJ**
Bronco '66 - '77*
Toyota trucks with space**
Other vehicles with space**



Part #032: Colors: 01
Exterior Dimensions: 24" L (includes cup holder) x 10" W x 18 1/2" H (includes 4" mounting bracket) 3 1/2" holes for drinks
Interior Dimensions: 15 1/2" L (top), 20" L (bottom) x 9 1/2" W x 12" H

FITS:
Wrangler YJ '87 - '90
CJ-7 '76 - '86
CJ-5 '76 - '83
Scout & Scout II
Ford trucks with space**
Chevy trucks with space**
Dodge trucks with space**
Utility van with space**
Other vehicles with space**



Part #016: Colors: 01, 03
Exterior Dimensions: 24" L (includes cup holder) x 12 1/2" W x 18 1/2" H (includes 4" mounting bracket) 3 1/2" holes for drinks
Interior Dimensions: 15 1/2" L (top), 20" L (bottom) x 12" W x 12" H

FITS:
Bronco '78 - '96
Blazer K5
Defender '90 - '95*
Ford trucks with space**
Chevy trucks with space**
Dodge trucks with space**
Utility van with space**
Other vehicles with space**

Mounting: Mounts through floor, drilling required (3) holes.

* = Console requires a special mounting kit. See mounting kits on this page.

** = Product will mount if sufficient space exists, additional hardware provided by customer or modifications to hardware may be required

Optional Accessories

| | | | |
|----------------------------------|-----------------------|----------------------|-----------------------|
| Mounting kits 057, 074, 076, 077 | 080 Finger Pull Lever | 862 12V Power Source | 034 Rear Drink Holder |
| | 870 Auto on/off Light | 863 Gas Strut | |

CONSOLE MOUNTING KITS



Mounting kit, Part #057-01

Mounting Kit Toyota Land Cruiser FJ-40 Years '73-'78. Use with Consoles Part #023 & #024

Mounting kit, Part #074-01

Mounting Kit Toyota Land Cruiser FJ-40 with factory rear heater. Month/Years 1/79-7/80. Use with consoles Part #023 & #024



Mounting kit, Part #076-01

Mounting Kit for Ford Bronco Years '66-'77. Use with Consoles Part #012 & #013



Mounting kit, Part #077-01

Mounting Kit for Land Rover Defender 90 & 110 Years up to '95. Use with Consoles Part #016 & #017

JK 2011+ SECURITY REAR CONSOLE



This 16 gauge steel rear half console provides 75% more secure storage than the plastic factory console. A special bracket is included for mounting a stereo, CB or other electronic equipment inside the lockable console. Inside the storage area there is a handy removable utility tray. Tuffy's 1/4" thick patented Pry-Guard II latching system secures the lid shut while a gas strut supports the lid when open.

The 2011+ JK Rear Half Console is used in conjunction with the front half of the factory console. It includes rear drink holders, but does not replace the original factory front cup holders. The console is taller than the OEM model and features a more comfortable full length padded armrest.

The console is designed to work in vehicles equipped with and without the rear power window switches. Each console accommodates all factory options such as the 12V power supply, 115V plug, and USB port. A divider is also included to gain more storage if the electronics bracket is not used.

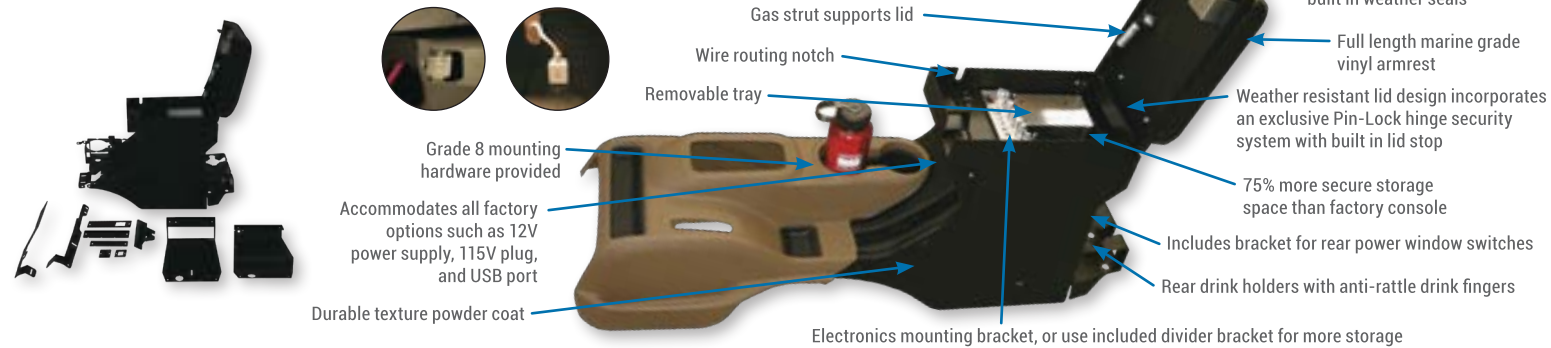

Part #274: Colors: Black - 01

Exterior Dimensions: 33"L x 8 1/4"W (top), 10 1/8"W (bottom) x 19 1/4"H (including armrest)

Interior Dimensions: 11"L x 7 1/2"W x 12 1/2"H

Electronics Compartment: Comes pre-cut for DIN Mount stereo 7 1/4" x 2 3/16". Max depth behind face plate is 7 7/8", Max clearance on top of face plate is 2 3/8". Equipment is mounted at 90°.

Mounting: OEM factory console is removed and the rear is replaced by the Tuffy Console. Mounts to the existing holes without drilling. Additional hardware is provided for optional added security which does not require drilling new holes. Front OEM shifter console with drink holders is still used with Tuffy console.

Optional Accessories: 150 Stereo Dash Tray | 151 Stereo Dash Cover | 870 Auto on/off Light

FITS:

Jeep Wrangler JK '11 - Current 2 & 4-Door
(Replaces the rear half of the OEM factory console with or without power window switches and with automatic or manual transmission)

JK '07-'10 SECURITY FULL CONSOLE



This 16 gauge steel full console provides over twice as much secure storage than the factory console. A special bracket is included for mounting a stereo, CB, or other electronic equipment inside the storage console with a hole for the CB Mic. Inside the storage area there is a handy 12 Volt marine grade power outlet and a removable utility tray. Tuffy's 1/4" thick patented Pry-Guard II latching system secures the lid shut while a gas strut supports the lid when open.

For convenience front and rear drink holders are included with anti-rattle drink fingers. The console is taller than the OEM model and features a much needed larger and more comfortable full length padded armrest.

The console is designed to work in vehicles equipped with and without rear power window switches. Each console includes brackets for both automatic and manual transmissions. A divider is also included to gain more storage if the electronics bracket is not used.

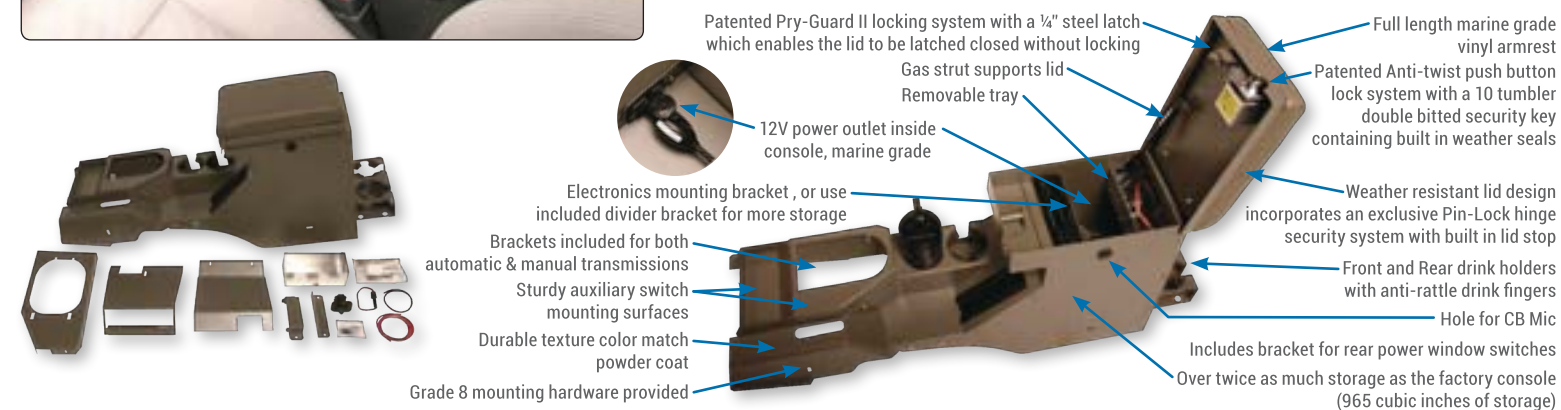

Part #157: Colors: Dark Slate - 08

Exterior Dimensions: 37"L x 10 3/4"W x 19 1/4"H (with padded armrest)

Interior Dimensions: 11"L (top), 7 1/2"L (bottom) x 7 1/2"W (top), 9 1/4"W (bottom) x 12 1/2"H

Electronics Compartment: Comes pre-cut for DIN Mount stereo 7 1/4" x 2 3/16". Max depth behind face plate is 7 7/8", Max clearance on top of face plate is 2 3/8". Equipment is mounted at 90°.

Power Outlet: 12V 15 Amp rated power outlet (cigarette lighter outlet type). Marine grade with protective cover.

Mounting: OEM factory console is removed and replaced by the Tuffy Console. The Tuffy console bolts to the existing holes without drilling. Additional hardware is provided for optional added security which requires drilling (2) holes.

Optional Accessories: 150 Stereo Dash Tray | 151 Stereo Dash Cover | 870 Auto on/off Light

FITS:

Jeep Wrangler JK '07 - '10, 2 & 4-Door
(Replaces OEM factory full or mini console with or without power window switches and with automatic or manual transmission)

JK 2011+ SECURITY CONSOLE INSERT



This fully enclosed console insert provides security and convenience, while maintaining the refined curves of the factory center console. It turns the factory 2011 Jeep Wrangler JK center console into a heavy-duty lockable storage area to help protect valuables from thieves' hands.

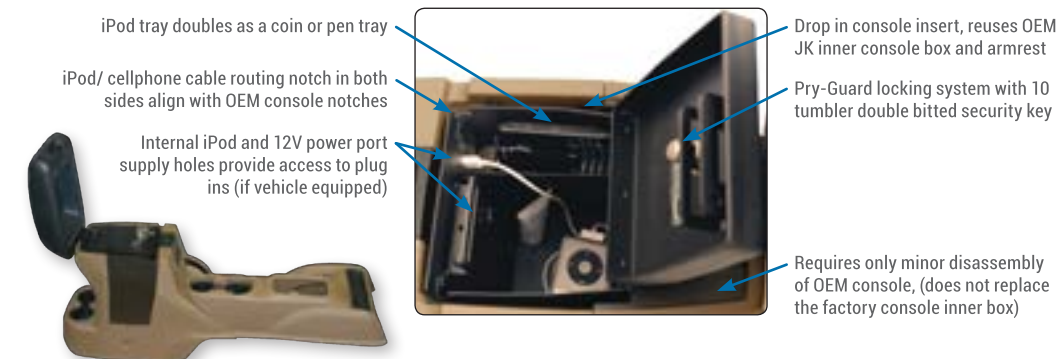

Part #276: Colors: Black - 01 (Plastic factory console not included)

Exterior Dimensions: 9"L x 6"W x 10 1/8"H (with mounting flange)

Interior Dimensions: 5 3/4"L (top), 4 5/8"L (bottom) x 5 7/8"W x 10"H

Mounting: OEM Factory console inner box and lid are retained. Console insert is a drop-in installation into the factory console inner box. The Tuffy insert bolts to existing holes without drilling. Additional hardware is provided for optional added security which requires drilling two holes.

Optional Accessories: 870 Auto on/off Light | 862 12V Power Source

FITS:

Jeep Wrangler JK '11 - Current 2 & 4-Door
(Used with OEM factory console, not a full console replacement)

FJ CRUISER SECURITY CONSOLE INSERT



This fully enclosed console insert adds lockable storage and convenience to the insecure factory console. It provides a comfortable and durable armrest while keeping the original factory drink holder. The unique design allows the driver side fold-down armrest to still be used.

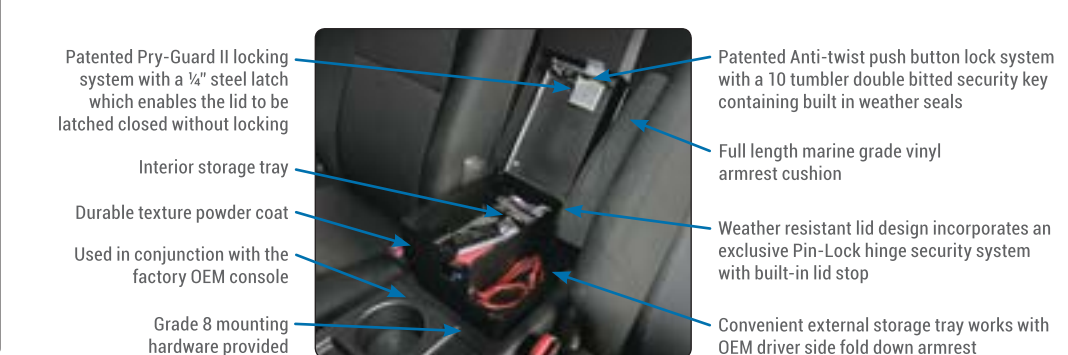

Part #144: Colors: Black - 01

Exterior Dimensions: 10 1/2"L x 8 5/8"W x 12 3/4"H (with padded cushion)

Interior Dimensions: 10 1/6"L (top), 5 1/2"L (bottom) x 5 3/4"W (top), 5 5/8"W (bottom) x 10 3/4"H

Mounting: No drilling required, mounts to the factory holes. Additional hardware is provided for optional security step which requires drilling. The OEM passenger side fold down armrest (if equipped) must be removed but is replaced by the Tuffy console armrest.

Optional Accessories: 870 Auto on/off Light | 862 12V Power Source | 863 Gas Strut

FITS:

Toyota FJ Cruiser '07 - Current
(Used with OEM factory console, not a full console replacement)

TJ SERIES II SECURITY FULL CONSOLE



This security console shares all the same features as the TJ Stereo Security Console except it incorporates two oversized drink holders in place of the separate stereo compartment. The front drink holders, padded armrest, and front console for levers are included in this model. The new sleek, custom fit design matches the TJ's refined interior and offers more interior storage.

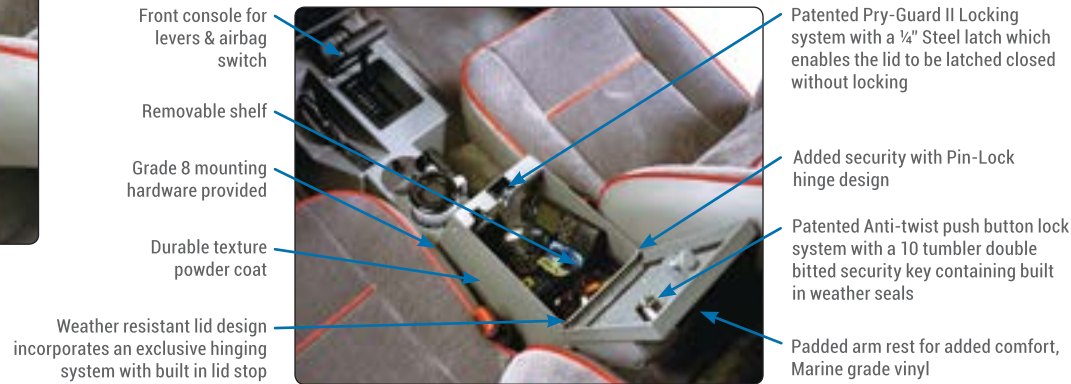

- Front console for levers & airbag switch
- Removable shelf
- Grade 8 mounting hardware provided
- Durable texture powder coat
- Weather resistant lid design incorporates an exclusive hinging system with built in lid stop
- Patented Pry-Guard II Locking system with a 1/4" Steel latch which enables the lid to be latched closed without locking
- Added security with Pin-Lock hinge design
- Patented Anti-twist push button lock system with a 10 tumbler double bitted security key containing built in weather seals
- Padded arm rest for added comfort, Marine grade vinyl

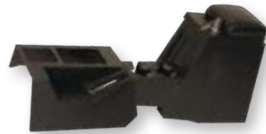

Part #040: Colors: Black - 01, Charcoal Gray - 03, Light Tan - 05, Dark Slate - 08

Exterior Dimensions: 36"L x 13"W x 17"H, 3 1/2" Holes for drinks

Interior Dimensions: (Length is tapered) 11 1/2"L x 8"W x 14"H (some interior space is lost to parking brake)

Mounting: Mounts to factory holes, some drilling required. Airbag disable switch is reinstalled in front console on some years. In 2001 or newer TJs a rear drink holder Part #070 may have to be purchased to cover cutout in carpet.

If any suspension or body lift modification has been done to the vehicle which affected the height of the shift lever will have to be modified.

Optional Accessories: 150 Stereo Dash Tray | 151 Stereo Dash Cover | 080 Finger Pull Lever | 870 Auto on/off Light 862 12V Power Source | 863 Gas Strut | 070 Rear Drink Holder

FITS:

Wrangler TJ '97 - '00
Wrangler TJ '01 - '06
(Without factory subwoofer)
Unlimited LJ '04 - '06
(Without factory subwoofer)

TJ STEREO SECURITY FULL CONSOLE



This security console has a separate lockable compartment for mounting a stereo or other electronic equipment. The rear compartment provides additional lockable storage for more valuables. The new sleek fit design and retractable stereo compartment lid matches the TJ's refined interior and offers more interior storage.

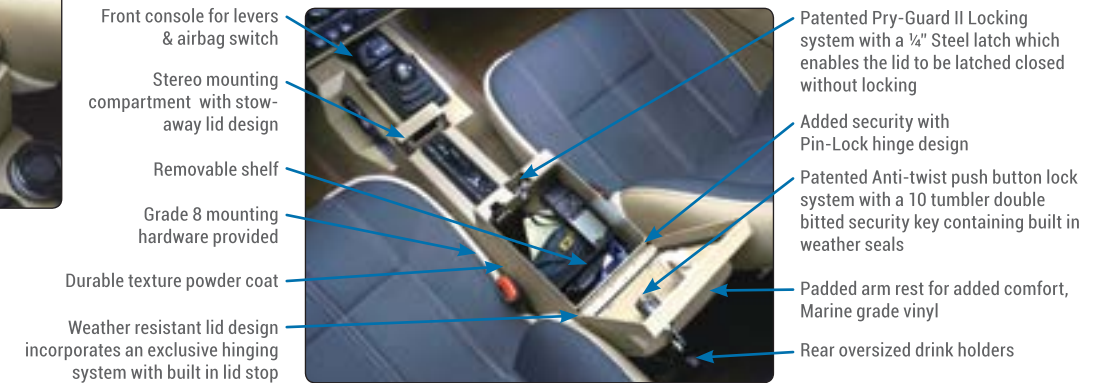
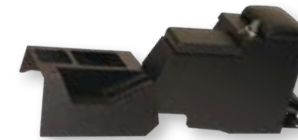

- Front console for levers & airbag switch
- Stereo mounting compartment with stow-away lid design
- Removable shelf
- Grade 8 mounting hardware provided
- Durable texture powder coat
- Weather resistant lid design incorporates an exclusive hinging system with built in lid stop
- Patented Pry-Guard II Locking system with a 1/4" Steel latch which enables the lid to be latched closed without locking
- Added security with Pin-Lock hinge design
- Patented Anti-twist push button lock system with a 10 tumbler double bitted security key containing built in weather seals
- Padded arm rest for added comfort, Marine grade vinyl
- Rear oversized drink holders

Part #041: Colors: Black - 01

Exterior Dimensions: 41 1/2"L x 13"W x 17"H, 3 1/2" Holes for drinks

Rear Compartment Interior Dimensions: (Length is tapered) 11 1/2"L x 8"W x 14"H (Some interior space is lost to parking brake)

Stereo Compartment: Comes pre-cut for DIN Mount stereo 7 1/4"L x 2 3/16"W x 7"D, 90° Angle (Stereo not included)

Mounting: Mounts to factory holes, some drilling required. Airbag disable switch is reinstalled in front console on some years. Stereo not included. *If any suspension or body lift modification has been done to the vehicle which affected the height of the shift lever, the lever will have to be modified.*

Optional Accessories: 150 Stereo Dash Tray | 151 Stereo Dash Cover | 080 Finger Pull Lever | 870 Auto on/off Light 862 12V Power Source | 863 Gas Strut

FITS:

Wrangler TJ '97 - '00
Wrangler TJ '01 - '06
(Without factory subwoofer)
Unlimited LJ '04 - '06
(Without factory subwoofer)

TJ SERIES II SECURITY CONSOLE (WITHOUT FRONT SHIFTER CONSOLE)



This console is designed for Jeep TJ Wranglers that did not come with a stock console. This console does not include the front console for levers. The sleek design matches the TJs refined interior and offers more storage space.

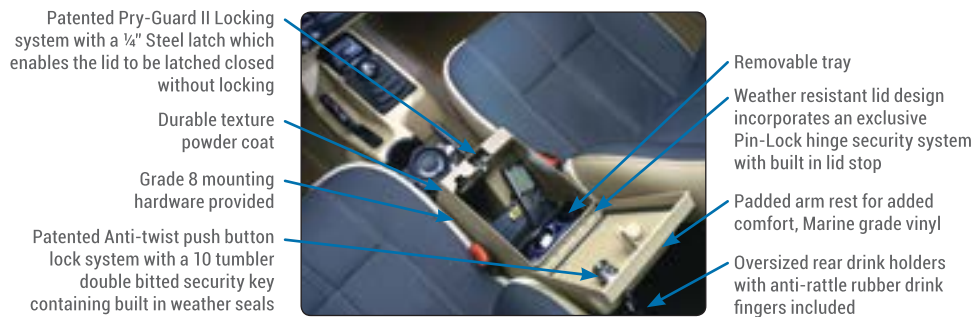

- Patented Pry-Guard II Locking system with a 1/4" Steel latch which enables the lid to be latched closed without locking
- Durable texture powder coat
- Grade 8 mounting hardware provided
- Patented Anti-twist push button lock system with a 10 tumbler double bitted security key containing built in weather seals
- Removable tray
- Weather resistant lid design incorporates an exclusive Pin-Lock hinge security system with built in lid stop
- Padded arm rest for added comfort, Marine grade vinyl
- Oversized rear drink holders with anti-rattle rubber drink fingers included

Part #044: Colors: Black - 01, Charcoal Gray - 03

Exterior Dimensions: 20 1/2"L x 8 1/2"W x 17"H, 3 1/2" Holes for drinks

Interior Dimensions: (Length is tapered) 11 1/2"L x 8"W x 14"H (some interior space is lost to parking brake)

Mounting: Mounts to factory holes, some drilling required.

Optional Accessories: 080 Finger Pull Lever | 870 Auto on/off Light | 862 12V Power Source | 863 Gas Strut

FITS:

Wrangler TJ '97 - '06
(Without factory console)
Unlimited LJ '04 - '06
(Without factory console)

TJ SPEAKER SECURITY FULL CONSOLE



This console has two drink holders in place of a separate stereo compartment and will accommodate the factory subwoofer or an 8" aftermarket speaker. The new sleek custom fit design matched the TJs refined interior while offering 2 1/2 times more storage than the factory model.

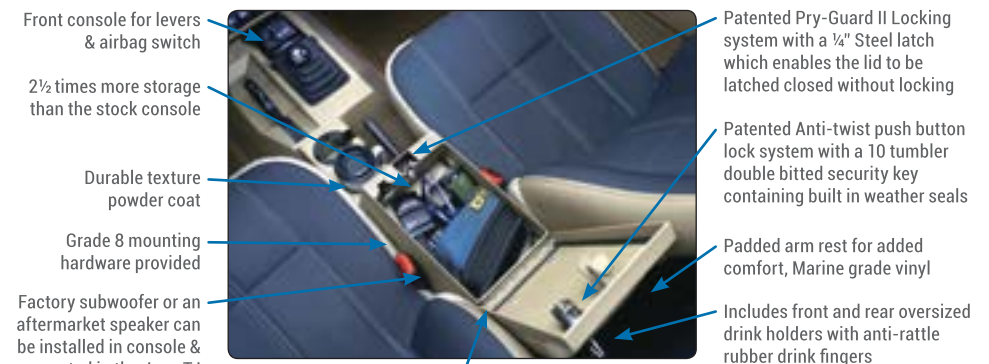

- Front console for levers & airbag switch
- 2 1/2 times more storage than the stock console
- Durable texture powder coat
- Grade 8 mounting hardware provided
- Factory subwoofer or an aftermarket speaker can be installed in console & mounted in the Jeep TJ
- Patented Pry-Guard II Locking system with a 1/4" Steel latch which enables the lid to be latched closed without locking
- Patented Anti-twist push button lock system with a 10 tumbler double bitted security key containing built in weather seals
- Padded arm rest for added comfort, Marine grade vinyl
- Includes front and rear oversized drink holders with anti-rattle rubber drink fingers

Weather resistant lid design incorporates an exclusive hinge Pin-Lock security system with built in lid stop

Holds 8" speaker. Grill Cut-out is 6 1/2" (speaker not included)

Part #066: Colors: Black - 01, Charcoal Gray - 03

Exterior Dimensions: 42 1/4"L x 8"W x 17"H, 3 1/2" Holes for drinks

Interior Dimensions: Rear Compartment: (Length is tapered) 11"L x 6 1/2"W x 5 1/4"H

Mounting: Mounts to factory holes, some drilling required. Airbag disable switch is re-installed in front console on some years. *Speaker not included. If any suspension or body lift modification has been done to the vehicle which affected the height of the shift lever, the lever will have to be modified.*

Optional Accessories: 080 Finger Pull Lever | 870 Auto on/off Light | 862 12V Power Source | 863 Gas Strut

FITS:

Wrangler TJ '97 - '00
(With aftermarket speaker)
Wrangler TJ '01 - '06
(With OEM or aftermarket speaker)
Unlimited LJ '04 - '06
(With OEM or aftermarket speaker)

TJ SECURITY REAR-HALF CONSOLE FOR SPEAKER



This console is specifically designed for use in the Jeep Wrangler TJ with the full factory console and subwoofer. It protects the expensive OEM subwoofer or aftermarket speaker and provides lockable storage for other valuables. The sleek design matches the TJs refined interior and offers 2½ times more storage than the factory console.

- Used in conjunction with the factory front console assembly
- Patented Pry-Guard II Locking system with a ¼" Steel latch which enables the lid to be latched closed without locking
- 6½" grill cutout for factory subwoofer or 8" aftermarket speaker
- Rear oversized drink holders with anti-rattle rubber drink fingers
- Grade 8 mounting hardware provided
- Weather resistant lid design incorporates an exclusive hinge Pin-Lock security system with built in lid stop
- Patented Anti-twist push button lock system with a 10 tumbler double bitted security key containing built in weather seals
- Padded arm rest for added comfort, Marine grade vinyl
- Durable texture powder coat

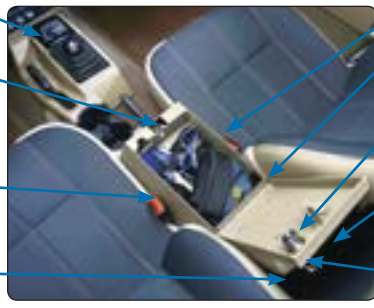

Part #055: Colors: Black - 01

Exterior Dimensions: 21"L x 8½"W x 17"H

Interior Dimensions: 11"L x 6½"W x 5¼"H; cutout for CDs 7"L x 4½"W x 5¼"H

Mounting: Mounts to factory holes, some drilling required. Replaces rear half of original OEM full length console, the front console for shifter is still used.

Optional Accessories: 080 Finger Pull Lever | 870 Auto on/off Light | 862 12V Power Source | 863 Gas Strut

FITS:

Wrangler TJ '01 - '06
(With full factory console and factory subwoofer cutout)
Unlimited LJ '04 - '06
(With full factory console and factory subwoofer cutout)

TJ SECURITY CONSOLE INSERT



This fully enclosed steel console insert replaces the OEM plastic insert and creates a secure, locking storage space while maintaining the look and fit of the factory TJ console.

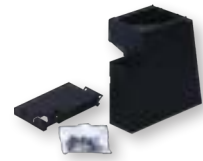

Pry-Guard Locking System with ⅛" steel and incorporates a 10 tumbler double bitted security lock

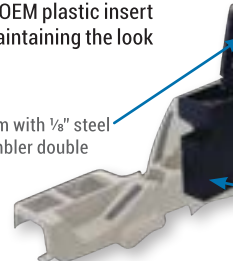

- Factory arm rest is used in conjunction with the console insert
- Durable texture powder coat
- Grade 8 mounting hardware provided
- Welded steel console and lid insert is used in conjunction with the factory OEM console shown installed

Part #062: Colors: Black - 01 (Plastic factory console not included)

Exterior Dimensions: 12"L x Width is tapered 6"W (top) 4"W (bottom) x 12 ¾"H

Interior Dimensions: Approximately the same as factory unit

Mounting: Console inserts into existing plastic console and is mounted through the floor, drilling required (2) holes.

Optional Accessories: 870 Auto on/off Light | 862 12V Power Source

FITS:

Wrangler TJ '97 - '00
(Used with OEM factory console, not a console replacement)

SAMURAI SECURITY CONSOLE



This console is designed for a Suzuki Samurai and offers an ideal location to secure valuables.

- Pry-Guard locking system with 10 tumbler double bitted security key
- Convenient removable tray
- Oversized drink holder with anti-rattle drink fingers
- Padded marine vinyl armrest cushion
- Durable texture powder coat
- Grade 8 mounting hardware provided

Part #052: Colors: Black - 01

Exterior Dimensions: 21¾"L (including drink holder) x 5¼"W x 13"H, 3½" Holes for drinks

Interior Dimensions: (Length is tapered) 12"L (top), 6¾"L (bottom) x 4¾"W x 9 ⅞"H (at rear - tapers up at front)

Mounting: Mounts through the floor, drilling required (4) holes.

Optional Accessories: 034 Rear Drink Holder | 090 Finger Pull Lever | 091 Lock Dust Cover | 870 Auto on/off Light | 862 12V Power Source | 863 Gas Strut

FITS:

Suzuki Samurai

SINGLE COMPARTMENT OVERHEAD CONSOLE



Part #142 shown, #103 only differs by its mounting brackets

This 16 gauge steel overhead security console has one lockable compartment for mounting a stereo, CB radio, speaker, or other electronic devices. The compartment door swings up flush and latches open. A bolt in stereo mounting tray makes installing a DIN mount stereo or CB radio a breeze.

Mounting: The console is expandable to fit between the roll bar and windshield. Mounts to factory holes, no drilling required.

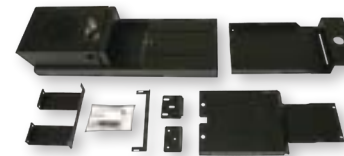

- Pre-punched hole for CB mic
- Single lock operation incorporating a high security 10 tumbler double bitted key
- Durable texture powder coat
- Footman loop mounting location for bikini top on part #103
- Convenient latch for holding door open
- One swing-away door
- 4" speaker grill cutout holds 5 ¼" speaker

Part #103: Color: Black - 01

Exterior Dimensions: (Length is adjustable) 28"L to 36½"L x 10¾"W x 4¼"H

Interior Dimensions: 7¼"W to 7¾"W x 10"D x 2 ⅛"H to 3¼"H (Bracket included to mount DIN Mount Stereo or CB Radio. Bracket is pre-cut measuring 7¼"W x 2 ⅛"H to 2 ⅝"H x 10"D) Will fit in a space measuring larger than 28" and less than 36½" between the two mounting points. Mounting can be modified for a full roll cage using (3) 2½" U-Bolts (not included) in the front.

FITS:

Unlimited LJ '04 - '06
Wrangler TJ '97 - '06
Wrangler YJ '87 - '95
CJ-7 '76 - '86
Other vehicles (with full roll cage)

Part #142: Color: Black - 01

Exterior Dimensions: (Length is adjustable by 8¾") 27¾"L to 36½"L x 10¾"W x 4¼"H

Interior Dimensions: 7¼"W to 7¾"W x 10"D x 2 ⅛"H to 3¼"H (Bracket included to mount DIN Mount Stereo or CB Radio. Bracket is pre-cut measuring 7¼"W x 2 ⅛"H to 2 ⅝"H x 10"D) Will fit in a space measuring larger than 27¾" and less than 36½" between the two mounting points. Mounting can be modified for a full roll cage using (3) 2½" U-Bolts (not included) in the front.

FITS:

Wrangler JK '07 - Current 2 & 4-Door

Optional Accessories: 150 Stereo Dash Tray

151 Stereo Dash Cover

TWO COMPARTMENT OVERHEAD SECURITY CONSOLE



This 16 gauge steel security console has (2) separate lockable compartments for mounting a stereo, CB radio, speaker, or other electronic devices. Compartments swing up flush with enclosure when closed and are secured by a single lock. This console can also be mounted to a full roll cage.

Mounting: The console is expandable to fit between roll bar and windshield. Mounts to factory holes, no drilling required.



- 4" speaker grill cutout holds 5 ¼" speaker
- Durable texture powder coat
- 2 swing-away doors
- Single lock operation incorporating a high security 10 tumbler double bitted key
- Footman loop mounting location for bikini top
- Pre-punched hole for CB mic.
- Convenient opening strap for pull-down doors

Part #048: Color: Black - 01

Exterior Dimensions: (Length is expandable) 32½"L to 36½"L x 9 ⅜"W x 4"H

Interior Dimensions: (2) compartments of equal dimensions (pre-cut for DIN Mount Stereo) 8 ⅞"D x 7¼"W x 2 ⅛"H. Will fit in a space measuring larger than 32½" and less than 36½" between two mounting points.

Optional Accessories: 150 Stereo Dash Tray | 151 Stereo Dash Cover

FITS:

Wrangler TJ '97 - '02
Wrangler YJ '87 - '95
CJ-7 '76 - '86
CJ-5 up to '83 (bracket and/or hardware will need to be modified)
Other vehicles w/ space

JK SECURITY GLOVE BOX



This 16 gauge steel, high security glove box is an ideal replacement for the plastic factory glove box. The glove box can be used to secure a number of smaller items. Tuffy's Patented latch system allows the glove box to be latched shut without having to be locked and unlocked each time it is accessed.



KEEP YOUR STUFF

We heard that the Tuffy glove box was a lot smaller than the factory one was. When we put them side by side, we saw that wasn't true. Even though the Tuffy latch takes up more space, we were able to fit all the stuff that stuffed the factory glove box into the Tuffy unit with no problems.

*From the January, 2013 issue of Jp
By Pete Trasborg*



Part #149: Colors: Black - 01, Dark Slate - 08
Exterior Dimensions: 11 5/8"W x 9 7/8"D x 11 1/8"H **Interior Dimensions:** 9"W x 9 1/4"D x 6 3/8"H
Mounting: No drilling required.

FITS:
Wrangler JK '07 - Current 2 & 4-Door
(best color match for JK 2011-current is 01 Black)

TJ & LJ SECURITY GLOVE BOX



This 16 gauge steel, high security glove box is an ideal replacement for the plastic factory glove box. The glove box can be used to secure a number of smaller items. Tuffy's Patented latch system allows the glove box to be latched shut without having to be locked and unlocked each time it is accessed.

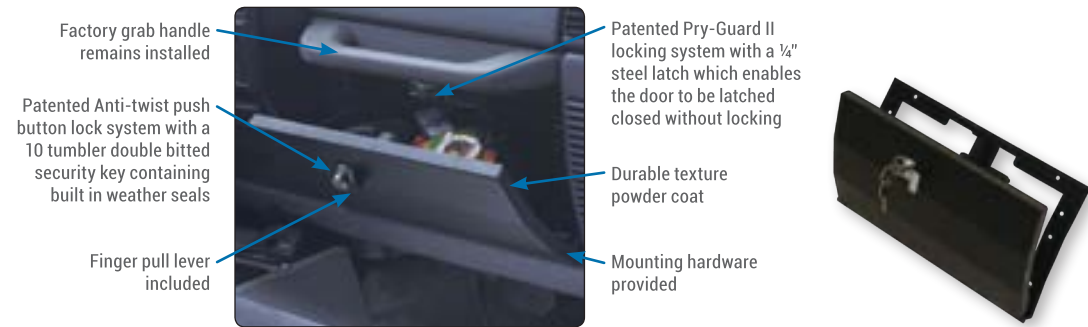

Part #049: Color: Black - 01, Charcoal Gray - 03, Light Tan - 05
Exterior Dimensions: (Lid) 15 1/2"L x 9 1/4"H
Interior Dimensions: 6 1/2"L (top), 5 5/8"L (bottom) x 12"W (front), 6 3/4"W (rear) x 4 1/4"H (front), 3 1/4"H (rear)
Mounting: Replaces factory glove box, drilling optional.

FITS:
Wrangler TJ '97 - '06
Unlimited LJ '04 - '06

CJ SECURITY GLOVE BOX



This 16 gauge steel high security glove box is an ideal replacement for the factory glove box. The glove box can be used to secure a number of smaller items. Tuffy's patented latch system allows the glove box to be latched shut without locking.



Part #035: Color: Black - 01
Exterior Dimensions: 6"L x 10 3/4"W x 5"H
Interior Dimensions: 4 1/4"L x 9 7/8"W x 4 1/2"H
Mounting: Replaces factory glove box, no drilling required.

FITS:
CJ-7 '76 - '86
CJ-5 '76 - '83

YJ SECURITY GLOVE BOX



This 16 gauge steel high security glove box is an ideal replacement for the plastic factory glove box. The glove box can be used to secure a number of smaller items.

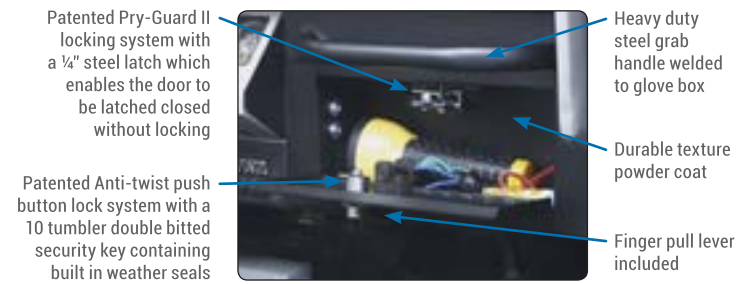

Part #036: Color: Black - 01
Exterior Dimensions: (Front plate) 14 3/4"W x 9 1/2"H
Interior Dimensions: 4 1/8"L x 11 1/2"W x 5 1/8"H
Mounting: Replaces factory glove box, no drilling required.

FITS:
Wrangler YJ '87 - '95

CLASSIC BRONCO SECURITY GLOVE BOX



This 16 gauge steel high security glove box is an ideal replacement for the plastic or cardboard factory glove box. The glove box can be used to secure a number of smaller items. The glove box features a split lid to accommodate a full sport-cage.

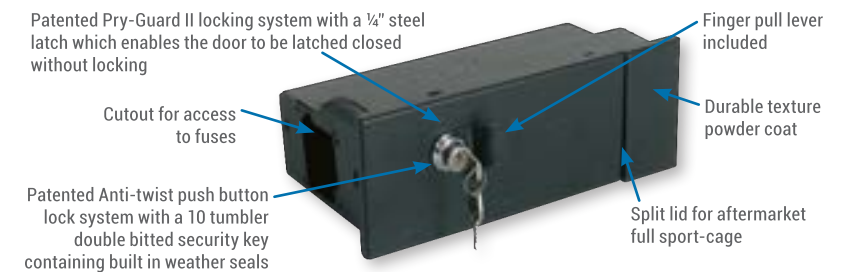

Part #108: Color: Black - 01
Interior Dimensions: 12 3/4"W x 6 1/2"D x 4 3/4"H
Mounting: Mounts easily in place of factory unit. No drilling required.

FITS:
Ford Bronco '66 - '77

JK FLIP-N-LOCK STEREO COVER



The locking stereo cover is a great way to secure valuable stereo equipment from the prying eyes of would be thieves. The unique design allows the locking cover to flip up and be stowed under the storage tray. Constructed from .090" Aluminum with a durable color matched powder coating finish. The cover is secured shut by Tuffy's exclusive double bitted 10 tumbler camlock system.



Step 1: Unlock & slide out Step 2: Flip lid down Step 3: Slide in and lock

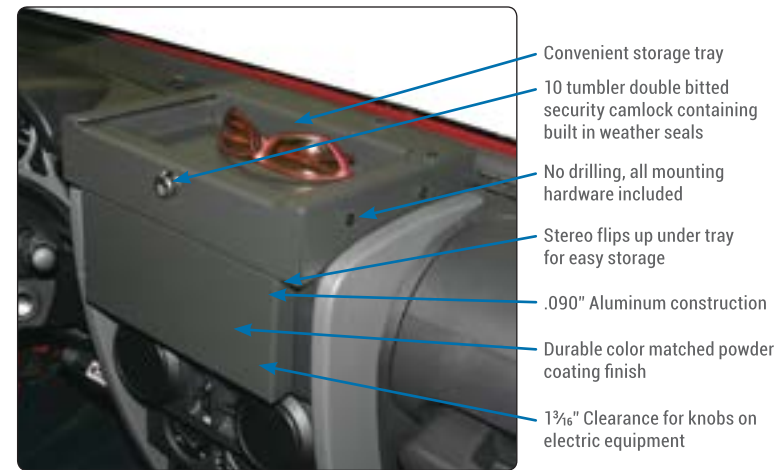

- Convenient storage tray
- 10 tumbler double bitted security camlock containing built in weather seals
- No drilling, all mounting hardware included
- Stereo flips up under tray for easy storage
- .090" Aluminum construction
- Durable color matched powder coating finish
- 1 1/16" Clearance for knobs on electric equipment

Part #160: Colors: Dark Slate - 08
Exterior Dimensions: 10 3/8"W x 9 1/4"D x 2 1/2"H Body
Lid Exterior Dimensions: 8 15/16"W x 1"D x 4 1/2"H, 13/16" Inside knob clearance at center bottom.
Tray Inside Dimensions: 8 3/8"W x 5 1/4"D x 1 1/8"H at sides
Mounting: No drilling required.

FITS:
 Wrangler JK '07 - '10 2 & 4-Door

SPEAKER SECURITY BOX SET



These 16 gauge steel security boxes are an ideal place to secure and mount a pair of 6"x9" speakers. These security boxes are closed using torx bolts with a security pin, tool is included.

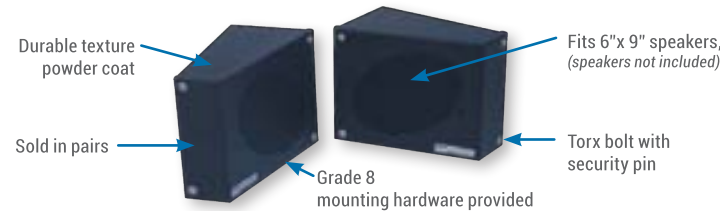

- Durable texture powder coat
- Sold in pairs
- Grade 8 mounting hardware provided
- Fits 6"x9" speakers, (speakers not included)
- Torx bolt with security pin

Part #019: Color: Black - 01
Exterior Dimensions: (Length is tapered) 4"L(front), 6 1/2"L(rear) x 10 1/2"W x 8 1/2"H
Mounting: Mounts through wheel wells, drilling required.
 Holes are not pre-drilled allowing them to be mounted in any direction.

FITS:
 Wrangler YJ '87 - '95 Any other vehicle with sufficient space
 CJ-7 '76 - '86
 CJ-5 up to '83

DUAL SPEAKER SECURITY BOX



Utilize unused space with this 16 gauge steel storage box which conveniently secures two 5 1/4" speakers. Special cloth is provided to cover the speakers inside the box to protect them from the elements. Security Tool for torx bolts is included.



- Durable texture powder coat
- Grade 8 mounting hardware provided
- Fits 5 1/4" speakers, speakers not included
- Torx bolt with security pin

Part #065: Color: Black - 01
Exterior Dimensions: (Length is tapered) 2"L(top), 4 3/8"L(bottom) x 11 3/4"W x 7 3/8"H
Mounting: Mounts through the floor of the vehicle, drilling required.

FITS:
 Wrangler YJ '87 - '95 Any other vehicle with sufficient space
 CJ-7 '76 - '86
 CJ-5 up to '83

SPEAKER & STORAGE SECURITY LOCK BOX SETS



WRANGLER YJ '92 - '95 | FJ-40 '64 - '84



Turn that unused space on top of the wheel wells into a convenient and secure place to mount 6" x 9" speakers, and lock up valuables. This 16 gauge steel lock box set comes equipped with a removable partition which divides the speaker and storage area.

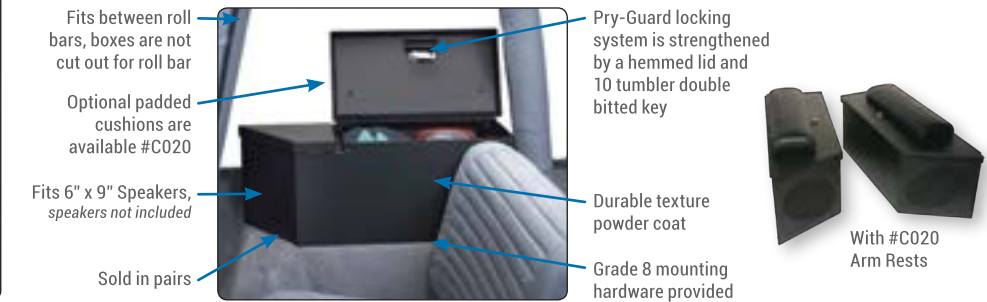

- Fits between roll bars, boxes are not cut out for roll bar
- Optional padded cushions are available #C020
- Fits 6" x 9" Speakers, speakers not included
- Sold in pairs
- Pry-Guard locking system is strengthened by a hemmed lid and 10 tumbler double bitted key
- Durable texture powder coat
- Grade 8 mounting hardware provided
- With #C020 Arm Rests

Part #020: Speaker Box Set, Color: Black - 01
Exterior Dimensions: (Length is tapered) 24 1/2"L to 19 1/2"L x 8 5/8"W x 9 5/8"H
Interior Dimensions Storage Compartment: 14 3/4"L x 8 1/4"W x 9"H
Mounting: Mounts through wheel wells, drilling required.
Optional Accessories: 090 Finger Pull Lever | 091 Lock Dust Cover | C020 Padded Cushions

Part #C020: Padded Cushion Set, Color: 01
Exterior Dimensions: 15 3/4" x 5 1/8"
 (Mounts on lids)

FITS:
 Wrangler YJ '92 - '95
 FJ-40 '64 - '84 (if sufficient space exists)
 Defender 90 up to '95

CJ-5 | CJ-7 | WRANGLER YJ '87 - '91

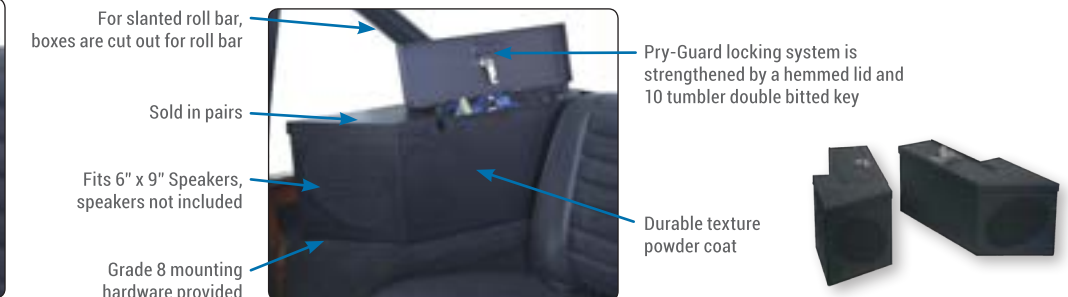

- For slanted roll bar, boxes are cut out for roll bar
- Sold in pairs
- Fits 6" x 9" Speakers, speakers not included
- Grade 8 mounting hardware provided
- Pry-Guard locking system is strengthened by a hemmed lid and 10 tumbler double bitted key
- Durable texture powder coat

Part #015: Color: Black - 01
Exterior Dimensions: (Length is tapered) 24 3/8"L to 19 1/2"L (length of cutout 11 5/8"L) x 8 5/8"W (at widest) x 9 1/2"H
Interior Dimensions Storage Compartment: 14 3/4"L x 5"W x 9"H
Mounting: Mounts through wheel wells, drilling required.
Optional Accessories: 090 Finger Pull Lever | 091 Lock Dust Cover

FITS:
 Wrangler YJ '87 - '91
 CJ-7 '76 - '86
 CJ-5 '76 - '83
 CJ-5 up to '75 (Additional mounting hardware required by customer)

WRANGLER TJ '97 - '06



Turn that unused space on top of the wheel wells into a convenient and secure place to mount 4" to 5" speakers, and lock up valuables. This lock box set comes equipped with a removable partition which divides the speaker and storage area.

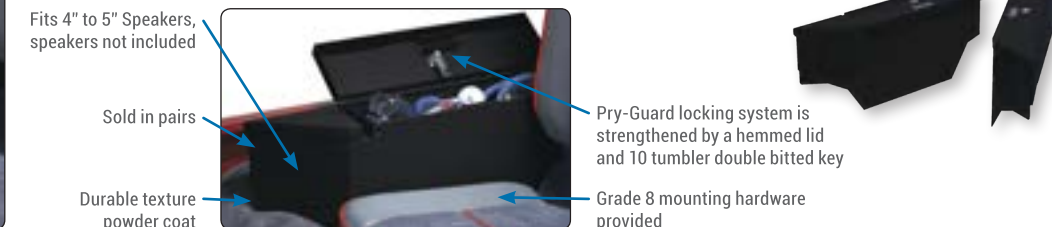

- Fits 4" to 5" Speakers, speakers not included
- Sold in pairs
- Durable texture powder coat
- Pry-Guard locking system is strengthened by a hemmed lid and 10 tumbler double bitted key
- Grade 8 mounting hardware provided

Part #047: Colors: Black - 01
Exterior Dimensions: 22 5/8"L x 4 1/2"W x 9 1/2"H **Interior Dimensions Storage Compartment:** 15 5/8"L x 4"W x 4 1/8"H
Mounting: Mounts through wheel wells, drilling required. Soft top will still fold down when boxes are mounted.
Optional Accessories: 090 Finger Pull Lever | 091 Lock Dust Cover

FITS:
 Wrangler TJ '97 - '06

TUFFY 2011+ JK DELUXE SECURITY DECK ENCLOSURE



LID ROTATES OPEN FOR EASY ACCESS

This deluxe security deck enclosure creates a large and lockable storage area. It works in conjunction with the vehicle rear door and lock. The lid easily hinges open and is secured shut using Tuffy's patented security system. In comparison with our #299 JK deck enclosure, the lid, vertical front panel and complete side panels can be easily removed without tools so larger items can be transported when required. The unique lid design is not attached to the front panel and is constructed from weight bearing structural welded steel.

The entire Tuffy deck enclosure is constructed using welded 16 gauge steel, heavy duty fasteners, and finished with a durable textured powder coating. The steel Tuffy side panel does not rely on the deck sidewall (wheel well) to create an enclosed space adding an additional level of security.

The patented design quickly and easily installs to the vehicle floor with standard hand tools in both 2 and 4 door models with and without an OEM hardtop. 2-door rear seat can still be used with the mounting system installed but it must be stowed, folded and tumbled when the entire deck enclosure is installed.

It functions with the OEM compartment cover, OEM Subwoofer and/or the Tuffy Cubby Cover Part#143. The vehicle power lock switches on the tailgate become disabled after approximately 16 seconds when locking the doors with the key fob so the enclosure remains secured. Any items stowed on top of the deck enclosure must be securely fastened to the vehicle.

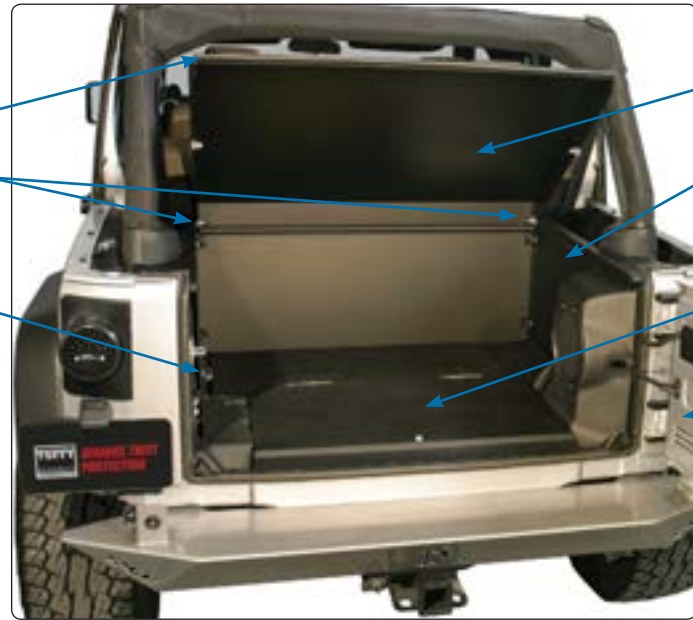

Includes built in weather seals.

Welded steel lid easily hinges open for access when the rear vehicle door is opened using Tuffy's patented security system.

Lid, vertical front panel and side panels are mounted to the vehicle floor and can be easily removed without tools.

Mounts to the vehicle floor in 2 and 4 door vehicles with an OEM hard or soft top.

Over 20,000 cubic inches of lockable storage space.

The steel Tuffy side panel does not rely on the deck sidewall (wheel well) to create an enclosed space adding an additional level of security.

Works with the OEM storage cover, OEM subwoofer and/or Tuffy Cubby Cover Part #143.

The large storage area is secured shut when the rear vehicle door is locked.

Includes all mounting hardware needed and does not require drilling.

US Patent No. 8256819, 8517445, 9039062, 9079625, Other Patents Pending.

Part #: 326

Color: Black - 01

Exterior Dimensions Overall: 31 3/8" L x 51" W x 17 1/2" H

Interior Dimensions: 31 1/4" L x 39 3/4" W x 17 1/8" H

Mounting: No drilling required. Mounting brackets are fastened to existing OEM mounting points in the vehicle floor. The side panels are fastened to the mounting brackets and joined by the front panel with quick hand operated knob screws. The top then inserts into the side panels and can be rotated open when the tailgate is open. The top, front and sides can be easily removed without tools.

Optional Accessories: 864-01-326 Diamond Vinyl Mat | 158 Tie Down Rails | 159 Gear Anchors

FITS:

Jeep Wrangler JK 2011 - Current, 2 & 4-Door models (with or without OEM hard or soft top).

On 2-Door models, the rear seat must be removed when the deck enclosure is installed.

The JK Deluxe Security Deck Enclosure functions with the OEM compartment cover, OEM Subwoofer and/or the Tuffy Cubby Cover Part# 143. (Does not fit 2007-2010 Wranglers - see Part# 173-Security Deck Enclosure)

TUFFY JK '07-'10 SECURITY DECK ENCLOSURE



LID ROTATES OPEN FOR EASY ACCESS

This security deck enclosure features a unique lid design is constructed from structural welded steel which incorporates a large weight bearing tray for organizing and transporting items on top. There are also two large trays on each side above the wheel well for addition storage and organization. US Patent No. 8,256,819 and 8,517,445.

Large storage area is secured shut when the rear vehicle door is locked

Hinged lid opens smoothly for easy access to cargo when the rear vehicle door is opened

Lid and front can be easily removed without tools

Weight bearing lid incorporates a unique storage tray

Mounts in vehicles with an OEM hard or soft top

Includes weather seals and all trays have built in external moisture drain holes

Includes all mounting hardware required and does not require drilling

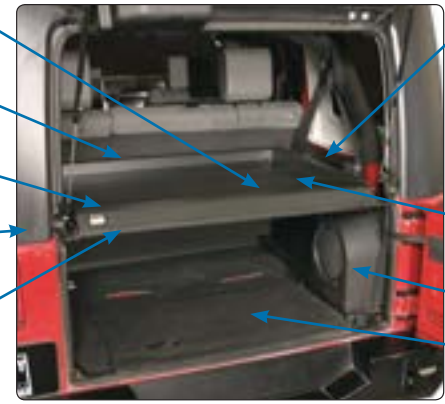

Two side organization trays included on top of the wheel wells

Optional diamond plate rubber mat available sold separately. Part #864-01-173

Mounts in vehicles with or without the OEM sub woofer

Works with the OEM storage cover or Tuffy Cubby Cover part #143

Part #173: Color: Black - 01

Exterior Dimensions Overall: 35 5/16" L x 52 5/16" W x 17 5/16" H

Interior Dimensions: 33 3/4" L (bottom) x 41 1/2" W x 15 1/2" H

Top Lid Tray Dimensions: 25 1/16" L x 37 3/8" W x 1 15/16" H

Side Tray Dimensions Inside: 15" L x 5 3/16" W x 2 5/16" H

Mounting: No drilling required. Side panels are fastened to existing mounting points in the vehicle. The front is fastened to the sides with quick hand operated knob screws. The top then inserts into catches in the sides. Top & front can be easily removed

Optional Accessories: 864-01-173 Diamond Vinyl Mat | 158 Tie Down Rails | 159 Gear Anchors

FITS:

Jeep Wrangler JK '07 - '10

(with or without OEM sub woofer and OEM hard or soft top)

4-Door models

2-Door models (with rear seat removed)

TUFFY TJ, LJ & YJ SECURITY DECK ENCLOSURE

This security deck enclosure creates a large and lockable storage area completely protected on all sides. It works in conjunction with the vehicle rear door and lock. The lid easily hinges open and is secured shut using an innovative latching system. The lid and front can be easily removed without tools so larger items can be transported when required. The unique lid design is constructed from structural welded steel which incorporates a large weight bearing tray for organizing and transporting items on top. There are also two large trays on each side above the wheel well for addition storage and organization.

The entire Tuffy deck enclosure is constructed using welded 16 gauge steel, heavy duty fasteners, and finished with a durable powder coating.

All trays have external drain holes to prevent puddling moisture. Mounts easily without drilling in TJs and LJs. Mounts easily in YJs to factory holes with optional drilling. Works with an OEM hard or soft top. Optional Rubber mat part# 864 is not included but can be ordered separately. US Patent No. 8,256,819 and 8,517,445.



LID ROTATES OPEN FOR EASY ACCESS

Large storage area is secured shut when the rear vehicle door is locked

Hinged lid opens smoothly for easy access to cargo when the rear vehicle door is opened

Lid and front can be easily removed without tools

Weight bearing lid incorporates a unique storage tray

Mounts in vehicles with an OEM hard or soft top

Mounts to factory holes and includes all mounting hardware required and does not require drilling

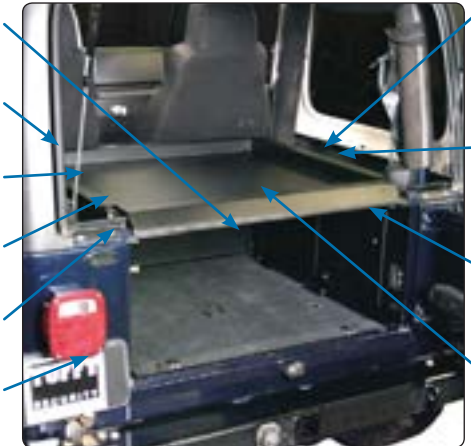

Two side organization trays included on top of the wheel wells

Includes weather seals and all trays have built in external moisture drain holes

Optional diamond plate rubber mat available sold separately. Part #864-01-173

Part #240: Color: Black - 01

Exterior Dimensions Overall: 35" L x 48 15/16" W x 17" H

Interior Dimensions: 34 15/16" L x 35 3/8" W x 14 15/16" H

Top Lid Tray Dimensions: 29 13/16" L x 33" W x 1 15/16" H

Side Tray Dimensions Inside: 18 9/16" L x 6 9/16" W x 1 3/4" H

Mounting: No drilling required in TJ & LJ, optional drilling in YJ. Side panels are fastened to existing mounting points in the vehicle with OEM hardware. The front is fastened to the sides with quick hand operated knob screws. The top then inserts into catches in the sides. The top and front can be easily removed.

Optional Accessories: 864-01-240 Diamond Vinyl Mat | 158 Tie Down Rails | 159 Gear Anchors

FITS:

Jeep Wrangler TJ (will not work with rear seat installed, it must be removed)

Jeep Wrangler LJ (will not work with rear seat installed, it must be removed)

Jeep Wrangler YJ (will not work with rear seat installed, it must be removed. Optional drilling suggested)

TUFFY JK UNLIMITED TAILGATE ENCLOSURE

WORKS IN THE 4-DOOR MODEL WITH THE REAR SEAT & THE 2-DOOR MODEL WITH THE REAR SEAT REMOVED



This all steel cargo enclosure is our simplest four-piece design yet that creates a lockable storage area completely protected on all sides. **In comparison with our #275 JK deck enclosure**, the top is fixed and outfitted with tie-down anchors. It does not rotate open but instead can be removed for storage of taller items.

It works in conjunction with the lockable vehicle tailgate to secure the area created. The enclosure maintains the use and function of the rear seat in 4-door models and will work in 2-door models with the rear seat removed providing Tuffy's largest secure cargo area available for the 2-door JK.

This jumbo sized enclosure quickly installs in both the 4 & 2-door Jeep JK models with an OEM hardtop or softtop. It will work in vehicles equipped with or without the subwoofer and functions with the OEM storage cover or the Tuffy Cubby Cover, part #143. The lid removes without the use of hand tools to allow for storage of large or tall items. Patent Pending.

On vehicles with power door locks, arming the security alarm disables the power door lock switches and ensures the tailgate and Tuffy enclosure are secure, even on softtop models or with the top removed.



Simple 4-piece design with integrated mounting hardware does not require drilling on 4-door model.

Instantly creates a secure storage area and has 1,368 in² of loadable deck space on top

Lid is weight bearing and provides storage on top
Includes perimeter weather seal

Provides over 22,000 cubic inches of lockable storage space (non-sub-woofer)

Mounts in 4 door vehicles & 2-door (without rear seat) with OEM hard or soft top

Lid can be removed without tools for transporting taller items

Functions with the OEM storage cover or the Tuffy Cubby Cover part #143

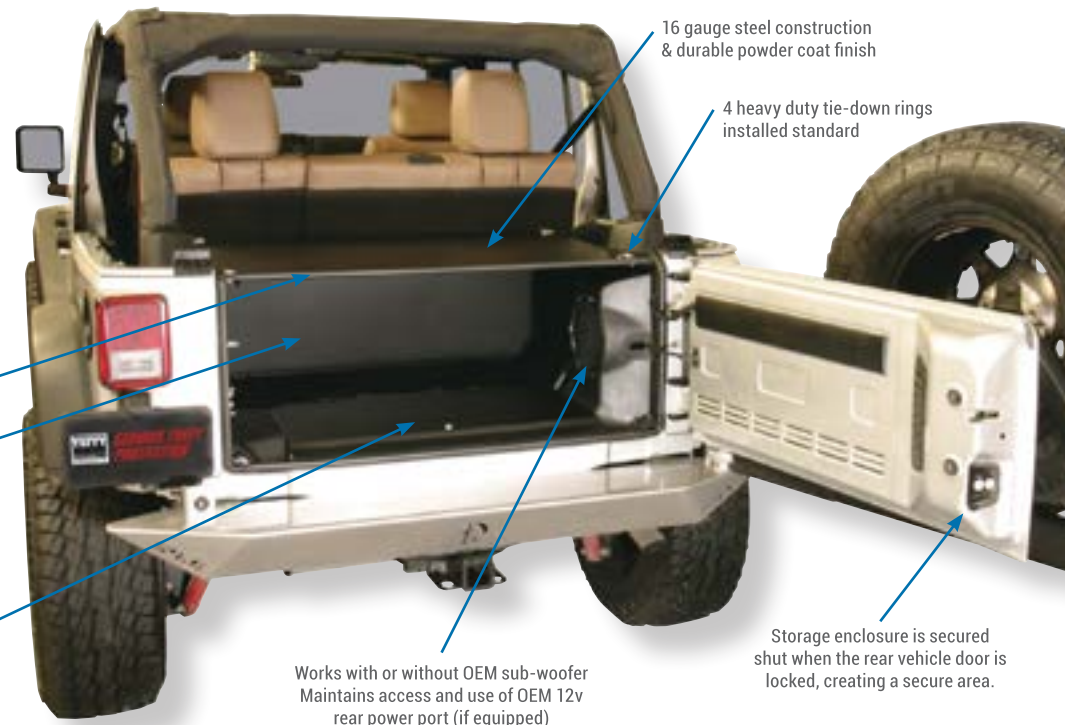

16 gauge steel construction & durable powder coat finish

4 heavy duty tie-down rings installed standard

Works with or without OEM sub-woofer
Maintains access and use of OEM 12v rear power port (if equipped)

Storage enclosure is secured shut when the rear vehicle door is locked, creating a secure area.

Part #299: Colors: Black - 01
Exterior Dimensions Overall: 34 3/8" L x 48 7/8" W x 16 1/2" H
Interior Dimensions (without sub-woofer): 32" L x 43" W x 15 1/2" H
Mounting: No Drilling required in 4-door model, front panel fastens to the existing vehicle mounting points.
Optional Accessories: 864-01-173 Diamond Vinyl Mat

FITS: Jeep Wrangler JK 2011-Current 4-door models with or without OEM sub-woofer and OEM hard or soft top.
Jeep Wrangler JK 2011-Current 2-door models with rear seat removed with or without OEM sub-woofer and OEM hard or soft top.
(May not fit with aftermarket rear window soft top bars)

Part #310: Colors: Black - 01
Exterior Dimensions Overall: 34 3/8" L x 48 7/8" W x 16 1/2" H
Interior Dimensions (without sub-woofer): 32" L x 43" W x 15 1/2" H
Mounting: No Drilling required in 4-door model, front panel fastens to the existing vehicle mounting points.
Optional Accessories: 864-01-173 Diamond Vinyl Mat

FITS: Jeep Wrangler JK 2007-2010 4-door models with or without OEM sub-woofer and OEM hard or soft top.
Jeep Wrangler JK 2007-2010 2-door models with rear seat removed with or without OEM sub-woofer and OEM hard or soft top.
(May not fit with aftermarket rear window soft top bars)

TUFFY 2011+ 2-DOOR JK TAILGATE SECURITY ENCLOSURE



This tailgate security enclosure is a simple, two-piece design that creates a lockable storage area completely protected on all sides. It works in conjunction with the lockable vehicle tailgate to secure the area created. The enclosure maintains the use and function of the rear seat in 2-door models.

Quickly and easily installs with standard hand tools in both 2 door Jeep models with an OEM hardtop or softtop. It will work in vehicles equipped with or without the subwoofer and functions with the OEM storage cover or the Tuffy Cubby Cover part #143. The lid removes easily without the use of tools to allow for storage of large or tall items. Patent Pending.

On vehicles with power door locks, arming the security alarm disables the power door lock switches and ensures the tailgate and Tuffy enclosure are secure, even on softtop models or with the top removed.



Instantly creates a lockable storage and is the best rear storage enclosure on the market
16 gauge steel construction & durable powder coat finish

Mounts in 2 door vehicles with OEM hard or soft top
Maintains use and function of the fold 'n tumble rear seat in 2-door model
Lid can be easily removed without tools for transporting taller items

Simple 2-piece design with integrated mounting hardware does not require drilling on 2-door model

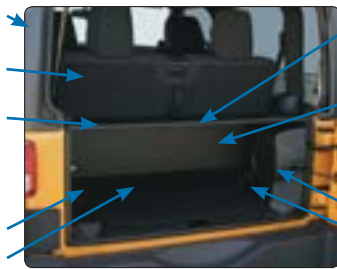

Lid is weight bearing and provides storage on top
Includes perimeter weather seal
Provides over 8,000 cubic inches of lockable storage space (non-sub-woofer)
Storage enclosure is secured shut when the rear vehicle door is locked, creating a secure area
Works with or without OEM sub-woofer
Maintains access and use of OEM 12v rear power port (if equipped)

Part #282: Colors: Black - 01
Exterior Dimensions Overall: 16 1/8" L x 48 3/8" W x 16 1/4" H
Interior Dimensions (without sub-woofer): 12 3/4" L x 42 3/8" W x 15" H
Mounting: No drilling required. Front panel fastens to existing vehicle mounting points on 2-door model. Lid can easily be removed. Additional hardware is provided for optional security which requires drilling two holes. **Optional Accessories:** 159 Gear Anchors

FITS: Jeep Wrangler JK 2011-Current 2-door models with or without OEM sub-woofer and OEM hard or soft top.
(May not fit with aftermarket rear window soft top bars)

TUFFY '07-'10 JK TAILGATE SECURITY ENCLOSURE



This tailgate security enclosure is a simple, two-piece design that creates a lockable storage area completely protected on all sides. It works in conjunction with the lockable vehicle tailgate to secure the area created. The enclosure maintains the use and function of the rear seat in 2-door models.

Quickly and easily installs with standard hand tools in both 2 door Jeep models with an OEM hardtop or softtop. It will work in vehicles equipped with or without the subwoofer and functions with the OEM storage cover or the Tuffy Cubby Cover part #143. The lid removes easily without the use of tools to allow for storage of large or tall items. Patent rights reserved.

On vehicles with power door locks, arming the security alarm automatically disables the power door lock switches and ensures the tailgate and Tuffy enclosure are secure, even on softtop models or with the top removed.

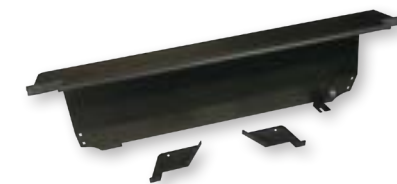

Instantly creates lockable storage and is the best rear storage enclosure on the market

Lid can be easily removed without tools for transporting taller items

Simple 2-piece design with integrated mounting hardware does not require drilling on 2-door model

Works with OEM storage cover or Tuffy Cubby Cover part #143

Mounts in 2 door vehicles with OEM hard or soft top
Maintains use and function of the fold 'n tumble rear seat in 2-door model

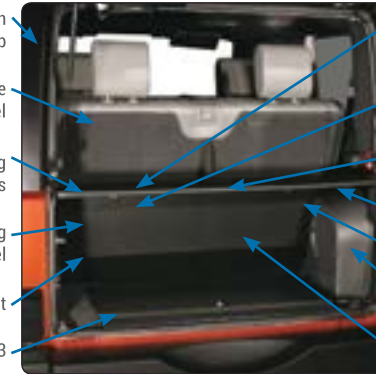

Storage enclosure is secured shut when the rear vehicle door is locked, creating a secure area
Provides over 7,000 cubic inches of lockable storage space (non-sub-woofer)
Lid is weight bearing and provides storage on top
Includes perimeter weather seal
Durable powder coat finish
Mounts in vehicles with or without OEM sub-woofer
16 gauge steel construction

Part #286: Colors: Black - 01
Exterior Dimensions Overall: 14 3/4" L x 48 3/8" W x 16 1/4" H
Interior Dimensions (without sub-woofer): 11" L x 42 3/8" W x 15" H
Mounting: No drilling required. Front panel fastens to existing vehicle mounting points on 2-door model. Lid can easily be removed. Additional hardware is provided for optional security which requires drilling two holes.
Optional Accessories: 159 Gear Anchors

FITS: Jeep Wrangler JK 2007-2010 2-door models with or without OEM sub-woofer and OEM hard or soft top.
(May not fit with aftermarket rear window soft top bars)

1997-2006 TJ WRANGLER SECURITY TAILGATE ENCLOSURE



This tailgate security enclosure is a simple, two-piece design that creates a lockable storage area completely protected on all sides. It works in conjunction with the lockable vehicle tailgate to secure the area created. The enclosure maintains the use and function of the rear seat.

Quickly and easily installs using standard hand tools in conjunction with an OEM hardtop or softtop. The lid removes easily without the use of tools to allow for storage of large or tall items.

On Jeep Wrangler TJ vehicles, the rear tailgate lock must be locked manually with the Jeep key in order for the Tuffy enclosure to function as a secure storage device.

Mounts in TJ with OEM hard or soft top

Maintains use and function of the fold 'n tumble rear seat in 2-door model

Lid can be easily removed without tools for transporting taller items

Simple 2-piece design with integrated mounting hardware does not require drilling on 2-door model

Instantly creates lockable storage and is the best rear storage enclosure on the market

16 gauge steel construction & durable powder coat finish

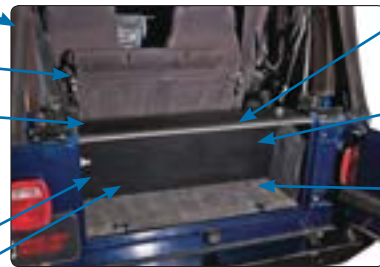

Lid is weight bearing and provides storage on top Includes perimeter weather seal

Provides over 5,500 cubic inches of lockable storage space

Storage enclosure is secured shut when the rear vehicle door is locked, creating a secure storage area

Patent Pending.

Part #296: Colors: Black - 01

Exterior Dimensions Overall: 16 1/16" L x 48 3/8"W x 15 3/8"H

Interior Dimensions (without sub-woofer): 12 3/4"L x 35 3/4"W x 15 1/4"H

Mounting: No drilling required. Front panel fastens to existing vehicle mounting points. Lid can easily be removed.

Optional Accessories: 159 Gear Anchors

FITS:

Jeep Wrangler TJ 1997-2006 with OEM hard or soft top.

REAR CARGO SECURITY LOCK BOX



This heavy duty, high security, 16 gauge steel lock box mounts in place of the rear seat.

The lockable trunk is great for tools, camping gear, equipment, and much more.

The lock box can be accessed through the large top lid, or through the independently opened rear door. A unique hinge design allows the lock box to be flush mounted without affecting the hinge operation.

Large top lid is supported by two gas lifts

13,800 cubic inches of storage space

Durable powder coat finish

Grade 8 mounting hardware included



Two patented Anti-twist push button lock systems with 10 tumbler double bitting security weather seals on both openings

Patented Pry-Guard II locking system with three 1/4" steel latches which enable both openings to be latched closed without locking

Independent rear door



Part #046: Color: Black - 01

Exterior Dimensions: 27"L x 35 3/8"W x 16"H **Rear Door Opening:** 23 15/16" W x 9 15/16"H

Interior Dimensions: 25 1/4"L x 35 1/4"W x 15 5/8"H

Mounting: Mounts through the floor using factory holes, some drilling required in CJ-5, JK, & LJ

Optional Accessories: 870 Auto on/off Light | 862 12V Power Source

864 Diamond Vinyl Mat | 860 Carpet Lining

FITS:

Wrangler JK '07 - Current 2-Door & 4-Door (with or without OEM subwoofer)
Unlimited LJ '04 - '06 (without carpet)

Wrangler TJ '97 - '06
Wrangler YJ '87 - '95
CJ-7 '76 - '86
CJ-5 up to '83 (additional hardware may be required)

1987-1995 YJ WRANGLER SECURITY TAILGATE ENCLOSURE



This tailgate security enclosure is a simple, two-piece design that creates a lockable storage area completely protected on all sides. It works in conjunction with the lockable vehicle tailgate to secure the area created. The enclosure maintains the use and function of the rear seat.

Quickly and easily installs using standard hand tools with an OEM hardtop or softtop. The lid removes with the use of tools to allow for storage of large or tall items.

On Jeep Wrangler YJ vehicles, the rear tailgate lock must be locked manually with the Jeep key in order for the Tuffy enclosure to function as a secure storage device.

Mounts in YJ with OEM hard or soft top

Maintains use and function of the fold 'n tumble rear seat in 2-door model

Lid can be easily removed with tools for transporting taller items

Simple 2-piece design with integrated mounting hardware does not require drilling

Instantly creates lockable storage and is the best rear storage enclosure on the market



Lid is weight bearing and provides storage on top Includes perimeter weather seal

Provides over 5,400 in³ of lockable storage space

Storage enclosure is secured shut when the rear vehicle door is locked, creating a secure storage area. 16 gauge steel construction & durable powder coat finish

Patent Pending.

Part #297: Colors: Black - 01

Exterior Dimensions Overall: 16 1/2" L x 47 1/16"W x 15 3/4"H

Interior Dimensions (without sub-woofer): 9 3/4"L x 35 3/4"W x 15"H

Mounting: No drilling required. Front panel fastens to existing vehicle mounting points. Lid can easily be removed.

Optional Accessories: 159 Gear Anchors

FITS:

Jeep Wrangler YJ 1987-1995 with OEM hard or soft top.

SUPER SECURITY STORAGE TRUNK



This high security trunk mounts behind the rear seat providing a secure place to store valuables.

Its universal shape makes it ideal for many other applications.

Patented Anti-twist push button lock system with a 10 tumbler double bitting security key containing built in weather seals

Large removable storage tray

3,320 cubic inches of storage space

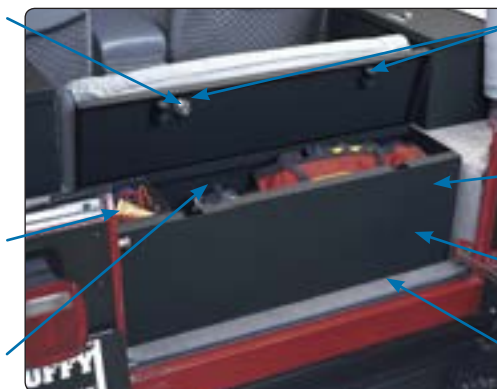

Patented Pry-Guard II locking system with two 1/4" steel latches which enable the lid to be latched closed without locking

Durable powder coat finish

16 gauge steel welded construction

Grade 8 mounting hardware included

Part #025: Color: Black - 01

Exterior Dimensions: 9 5/8"L x 33 7/8"W x 11 3/8"H

Interior Dimensions: (Opening 8 1/2" x 33 1/8") 9"L x 33 1/8"W x 11 1/8"H

Tray Dimensions: 9"L x 6 1/4"W x 3"H

Mounting: Mounts through the floor, drilling required.

OPTIONAL ACCESSORIES: 870 Auto on/off Light | 862 12V Power Source

864 Diamond Vinyl Mat | 860 Carpet Lining | 863 Gas Strut

FITS:

Wrangler YJ '87 - '95
CJ-7 '76 - '86
CJ-5 up to '83 (without back seat)
Defender 90 (on wheel well)
Bronco '66 -'77
Any other vehicle with space

SECURITY BOLT LOCKER



This welded steel bolt locker secures up to a 3/16" diameter bolt, preventing access to the head with a wrench. The bolt lock is great for securing winches, racks, mounted tools, and other bolt on items. The locker is secured with a double bitted 10 tumbler Tuffy lock with an exclusive cam latching design.

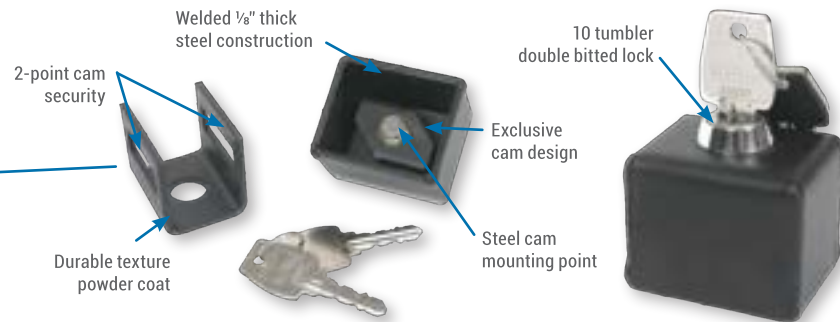

Part #104: Colors: Black - 01
Interior Dimensions: 2 1/8"L x 1 3/4"W x 2"H
Mounting: Easy bolt on installation, no drilling required.
Optional Accessories: 091 Lock Dust Cover

FITS:
 Any vehicle
 Up to a 3/16" diameter bolt

TUFFY FLIP-UP LICENSE PLATE HOLDER ROLLER AND HAWSE FAIRLEAD OPTIONS



If you have a winch on your vehicle and your state requires a front license plate, here's the solution! Tuffy's Flip-up License Plate Holder allows your front license plate to attach firmly to your winch fairleads and flips out of the way when you need to use your winch. It's made of durable 16 gauge steel instead of plastic like others on the market and includes hardware for attaching the license plate.

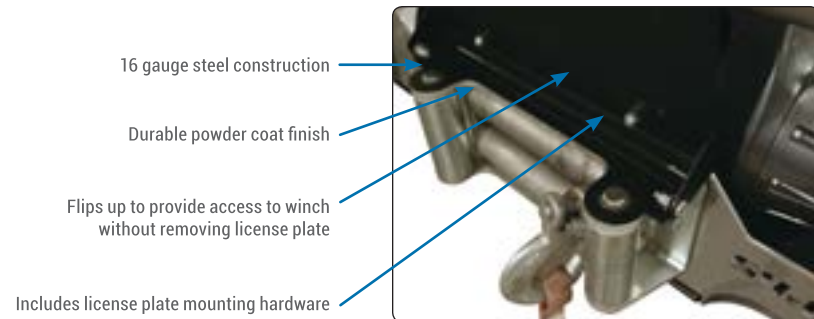

Part #189: Color: Black-01. Works with Standard Roller Fairlead with pin dia .615" (Aprox 5/8") spaced 8.776" (Aprox 8 3/4") apart.
Part #333: Color: Black-01. Works with Standard Hawse Fairlead with mounting hardware up to 5/8" diameter at 10" (center to center).

FITS:
 Roller fairlead - Part 189
 Hawse fairlead - Part 333

HOOD LATCH GUARDS



Without a Hood Latch Guard in place, a thief can stick a long screwdriver through your front grill and release the hood from the outside! Once under the hood they can disable your alarm, steal your battery, valuable engine parts, or HID headlights.

FEATURES: Prevents access to front hood release from front grille | Bolt on theft prevention protects cable and latch Comes with complete instructions and necessary hardware.

Part #877: (Visit www.tuffypromts.com for specific part numbers & details)

Mounting: Bolt on protection, comes with complete instructions and necessary hardware. No drilling required.

FITS:
 Cadillac Escalade/EXT 2002-2007
 Chevy Avalanche 2002-2007
 Chevy Colorado 2006+
 Chevy Silverado 1999-2007

Chevy Suburban 2000-2007
 Chevy Tahoe 2000-2007
 Ford F-150 2004+
 Ford F-250/F-350 Super Duty 1999+

Ford Excursion 2000-2005
 Ford Expedition 2003+
 GMC Canyon 2006+
 GMC Sierra 1999-2007

GMC Yukon 2000-2007
 Hummer H3 2006-2007
 Lincoln Navigator 2003+

TUFFY WRANGLER HOOD LOCKS

The only reasonably priced hood lock on the market that actually works! This hood lock is a simple one-piece design that secures the hood and deters thieves from walking away with valuable under hood parts such as batteries, intakes, superchargers, etc. It installs easily with included hardware and does not require drilling. When locked it guards the hood from being raised and protects the hood latch from being pried open. Keep your costly under hood investments safe with the Tuffy Hood Lock.

Wrangler JK



Wrangler TJ & LJ



Wrangler YJ



Features:

- 11 gauge (1/8 in.) Steel construction
- Durable powder coat finish
- Simple 1-piece design does not require drilling
- The only reasonably priced JK hood lock on the market that actually works!
- Can be keyed alike to match your other Tuffy products
- Hood lock provides additional latch support to reduce wind buffeting of hood during highway driving
- When locked it guards the hood from being raised and protects the hood latch from being pried open
- Available #091 Lock Dust Cover sold separately
- 10 tumbler double bitted security key locking system

Wrangler JK

Part #292: Colors: Black - 01
Exterior Dimensions: 3"L x 4 5/8"W x 4"H

Wrangler TJ & LJ

Part #137: Colors: Black - 01
Exterior Dimensions: 5 1/4"L x 3 1/2"W x 2 3/16"H

Wrangler YJ

Part #295: Colors: Black - 01
Exterior Dimensions: 8 1/4"L x 2 3/4"W x 3 5/16"H

Mounting: Mounts behind the OEM grill with OEM hardware. Does not require drilling.
Optional Accessories: 091 Lock Dust Cover

FITS:
 Jeep Wrangler JK '07 - Current
 2-Door & 4-Door

FITS:
 Wrangler TJ 97-06
 *Fits '97 TJ's with hood mounted latch hook only
 Unlimited LJ 04-06

FITS:
 Wrangler YJ 1987-1995

TUFFY WRANGLER DOOR LOCKERS

Wrangler JK

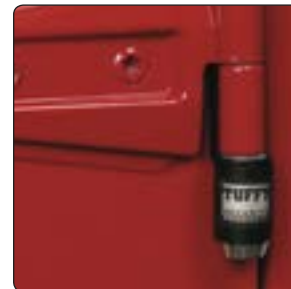

Wrangler YJ & CJ

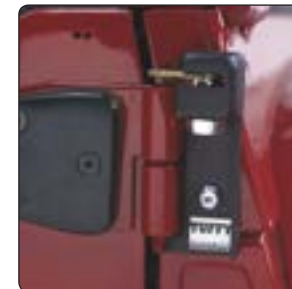

Wrangler TJ & LJ



These external door lockers provide theft protection for otherwise vulnerable Jeep hard doors. The door lockers function to prevent the expensive doors from being lifted off and resold for big bucks.

The high security 10 tumbler locks allow the owner to unlock and remove the door locker assembly and then remove the hard doors.

Constructed using heavy duty machined and welded steel and finished with an attractive powder coat finish. All mounting hardware is included.

Features:

These are easy to install and use.

- Replaces vulnerable OEM fastener
- Innovative design only allows door to be removed when door locker is unfastened
- All mounting hardware included and installs in minutes!
- Constructed using heavy duty welded steel
- Durable texture powder coat finish
- High security 10 tumbler double bitted security lock

Wrangler JK

Part #164: 4-Door JK model Colors: Black - 01
(includes 4 door locker assemblies and 2 keys)

Part #165: 2-Door JK model Colors: Black - 01
(includes 2 door locker assemblies and 2 keys)

Mounting: No drilling required. Remove the OEM door hardware and fasten the Tuffy inside assembly to the door hinge then insert exterior assembly and lock to prevent access

Wrangler YJ & CJ

Part #037: Colors: Black - 01
(only works with OEM factory full or half hard doors)

Mounting: Mounts through top body hinge, no drilling required.

Wrangler TJ

Part #043: Colors: Black - 01 *(only works with OEM factory full or half hard doors)*

Mounting: Mounts through top body hinge, no drilling required.

FITS:
 Jeep Wrangler JK '07 - Current
 with both OEM full and half doors
(separate part number for 2 and 4-Door applications)

FITS:
 Wrangler YJ '87 - '95
 CJ-7 '76 - '86
 CJ-5 up to '83

FITS:
 Wrangler TJ '97 - '06
 Unlimited LJ '04 - '06

HEAVY DUTY TRUCK BED SECURITY DRAWERS



Tuffy Security Product's Heavy Duty Gear Drawers are perfect for anyone wanting organization and heavy duty security. These drawers are specifically designed for outdoor use and are completely encased, producing an extremely weather resistant design.

The large drawers open smoothly on Tuffy's exclusive slide system incorporating (8) heavy duty precision stainless steel roller bearings. In addition, Tuffy's Heavy Duty Gear drawers are rated to 2000 lbs. on top.

They can be securely locked with Tuffy's patented locking system to provide protection for outdoor equipment and other valuables. Each drawer features Tuffy's patented Pry-Guard II locking system which incorporates a 1/4" thick steel security latch.

Unlike other cabinet type drawers on the market that use retrofitted cabinet or house locks, the Tuffy drawer incorporates a patented pushbutton latching mechanism similar to typical OEM automotive door latches. This type of latching system secures the drawer shut while operating the vehicle without the need to lock and unlock the drawer every time access is needed. When higher security is required, the drawer can be locked as well.

All of Tuffy's drawers and other locking vehicle accessories can be keyed alike with a highly secure 10 Tumbler double bitted key.

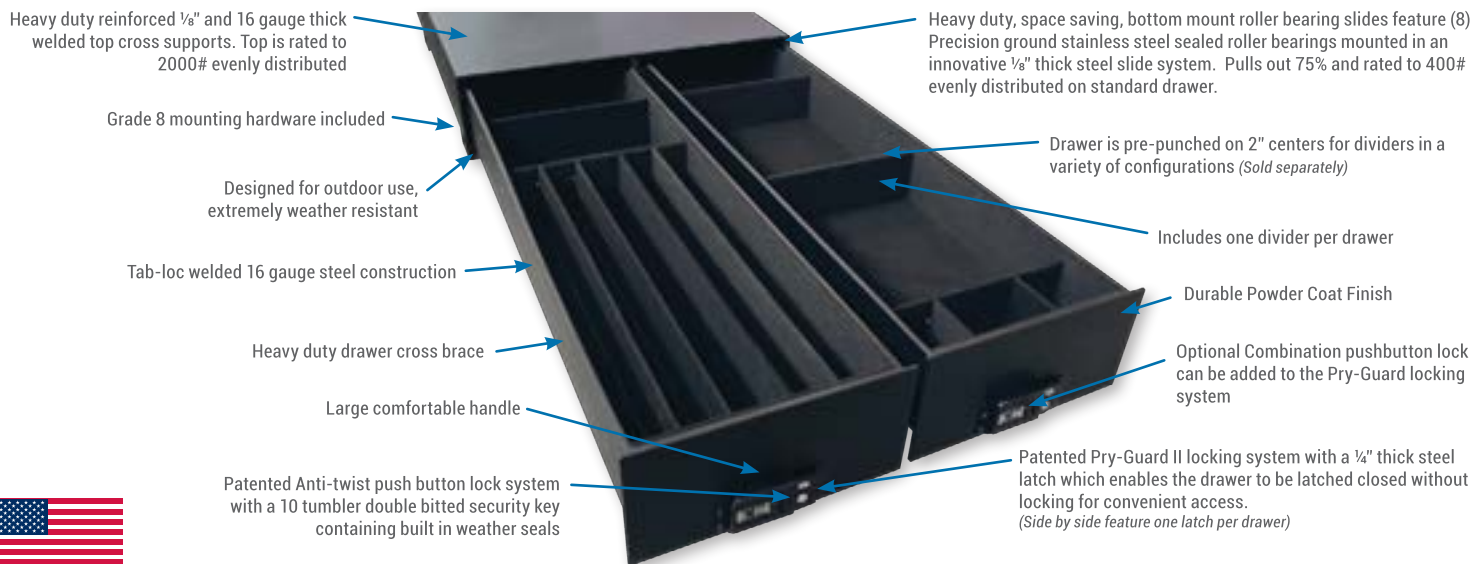

Heavy duty reinforced 1/8" and 16 gauge thick welded top cross supports. Top is rated to 2000# evenly distributed

Grade 8 mounting hardware included

Designed for outdoor use, extremely weather resistant

Tab-loc welded 16 gauge steel construction

Heavy duty drawer cross brace

Large comfortable handle

Patented Anti-twist push button lock system with a 10 tumbler double bitted security key containing built in weather seals

Heavy duty, space saving, bottom mount roller bearing slides feature (8) Precision ground stainless steel sealed roller bearings mounted in an innovative 1/8" thick steel slide system. Pulls out 75% and rated to 400# evenly distributed on standard drawer.

Drawer is pre-punched on 2" centers for dividers in a variety of configurations (Sold separately)

Includes one divider per drawer

Durable Powder Coat Finish

Optional Combination pushbutton lock can be added to the Pry-Guard locking system

Patented Pry-Guard II locking system with a 1/4" thick steel latch which enables the drawer to be latched closed without locking for convenient access. (Side by side feature one latch per drawer)



Part #257: Color: Black - 01 2 Drawers 50/50 Split
Standard Sizes:

| | | |
|---|---|---|
| Exterior: 64 3/4"L x 47 3/4"W x 10"H Interior of each Drawer: 61.75"L x 21.55"W x 6.3"H | Exterior: 74 3/4"L x 47 3/4"W x 10"H Interior of each Drawer: 71.75"L x 21.55"W x 6.3"H | Exterior: 94 3/4"L x 47 3/4"W x 10"H Interior of each Drawer: 91.75"L x 21.55"W x 6.3"H |
| Exterior: 64 3/4"L x 47 3/4"W x 14"H Interior of each Drawer: 61.75"L x 21.55"W x 10.3"H | Exterior: 74 3/4"L x 47 3/4"W x 14"H Interior of each Drawer: 71.75"L x 21.55"W x 10.3"H | Exterior: 94 3/4"L x 47 3/4"W x 14"H Interior of each Drawer: 91.75"L x 21.55"W x 10.3"H |

Mounting: Mounts directly to flat surface with the hardware provided, drilling required.

Options: Pushbutton combination lock added to the Pry-guard II system.

Optional Accessories: Part #268 Side to Side Divider Kit | Part #269 Side to Side Divider Carpet Finish Kit | Part #270 Front to Back Divider Kit | Part #271 Side to Side Divider Carpet Finish Kit | Part #272 Drawer Interior Finish Kit | Part #273 Drawer Exterior Finish Kit | Part #864 Rubber mat | Part #158, Gear anchors | Part #159, Tie down rails

Fits: Trucks, Vans, and SUVs with sufficient mounting space.

FULLY CUSTOMIZABLE SECURITY DRAWERS

Tuffy Security Product's Tactical Gear Security Drawers are the state of the art in secure gear storage and organization. These highly functional, highly secure, and fully customizable drawer units are precision crafted in the USA. Configurations are available for most foreign and domestic SUVs, trucks and sedans.

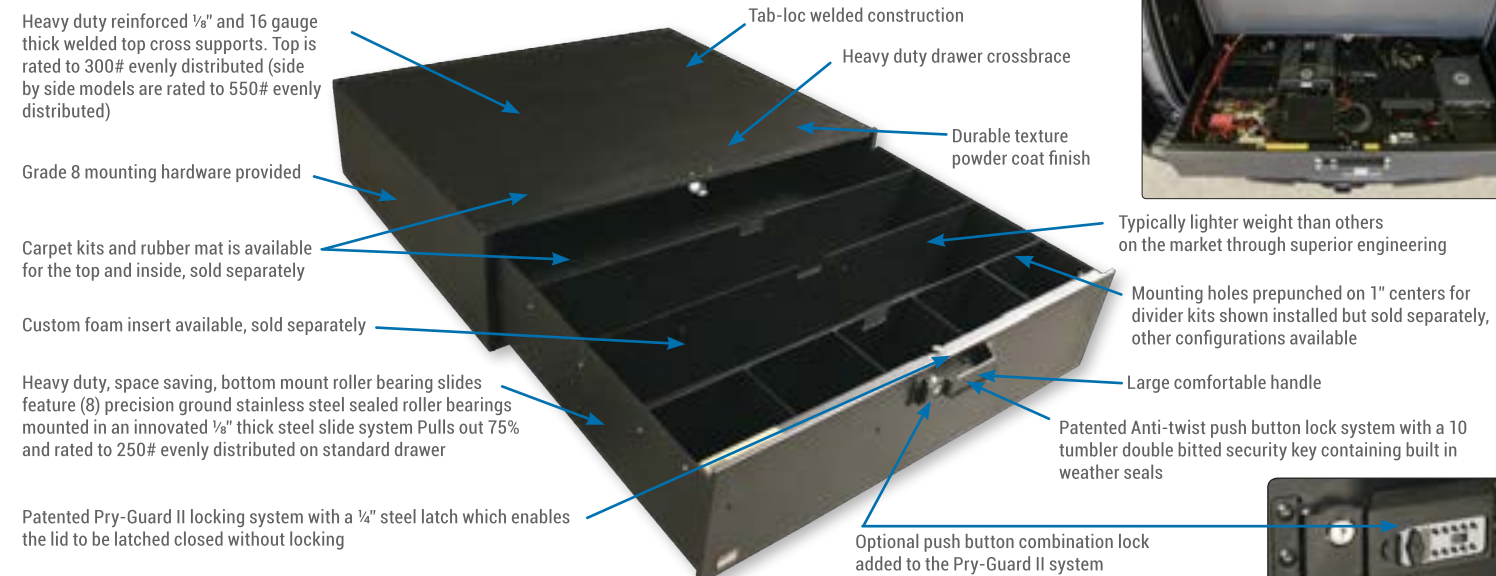

Heavy duty reinforced 1/8" and 16 gauge thick welded top cross supports. Top is rated to 300# evenly distributed (side by side models are rated to 550# evenly distributed)

Grade 8 mounting hardware provided

Carpet kits and rubber mat is available for the top and inside, sold separately

Custom foam insert available, sold separately

Heavy duty, space saving, bottom mount roller bearing slides feature (8) precision ground stainless steel sealed roller bearings mounted in an innovated 1/8" thick steel slide system Pulls out 75% and rated to 250# evenly distributed on standard drawer

Patented Pry-Guard II locking system with a 1/4" steel latch which enables the lid to be latched closed without locking

Tab-loc welded construction

Heavy duty drawer crossbrace

Durable texture powder coat finish

Typically lighter weight than others on the market through superior engineering

Mounting holes prepunched on 1" centers for divider kits shown installed but sold separately, other configurations available

Large comfortable handle

Patented Anti-twist push button lock system with a 10 tumbler double bitted security key containing built in weather seals

Optional push button combination lock added to the Pry-Guard II system



- Part #167-450390160-000-01:** Colors: Black
Exterior Dimensions: 45"W x 39"L (Plus 1 1/4" for handle) x 16"H
Interior Dimensions: 42 3/4"W x 38 9/16"L x 13 1/4"H (Less 1 9/16" at center for striker)
 - Part #167-400360160-000-01:** Colors: Black
Exterior Dimensions: 40"W x 36"L (Plus 1 1/4" for handle) x 16"H
Interior Dimensions: 37 3/4"W x 35 9/16"L x 13 1/4"H (Less 1 9/16" at center for striker)
 - Part #167-120570140-000-01:** Colors: Black
Exterior Dimensions: 12"W x 57"L (Plus 1 1/4" for handle) x 14"H
Interior Dimensions: 9 3/4"W x 56 9/16"L x 11 1/4"H (Less 1 9/16" at center for striker)
 - Part #167-400270120-000-01:** Colors: Black
Exterior Dimensions: 40"W x 27"L (Plus 1 1/4" for handle) x 12"H
Interior Dimensions: 37 3/4"W x 26 9/16"L x 9 1/4"H (Less 1 9/16" at center for striker)
 - Part #167-480140090-000-01:** Colors: Black
Exterior Dimensions: 48"W x 14"L (Plus 1 1/4" for handle) x 9"H
Interior Dimensions: 45 3/4"W x 13 9/16"L x 6 1/4"H (Less 1 9/16" at center for striker)
 - Part #167-470410160-000-01:** Colors: Black
Exterior Dimensions: 47"W x 41"L (Plus 1 1/4" for handle) x 16"H
Interior Dimensions: 44 3/4"W x 40 9/16"L x 13 1/4"H (Less 1 9/16" at center for striker)
 - Part #167-420220080-000-01:** Colors: Black
Exterior Dimensions: 42" W x 22" L (Plus 1 1/4" for handle) x 8" H
Interior Dimensions: 39 3/4" W x 21 9/16" L x 5 3/8" H (Less 1 9/16" at center for striker)
 - Part #167-400360160-000-01:** Colors: Black
Exterior Dimensions: 40"W x 30"L (Plus 1 1/4" for handle) x 16"H
Interior Dimensions: 37 3/4"W x 29 9/16"L x 13 1/4"H (Less 1 9/16" at center for striker)
 - Part #167-400240160-000-01:** Colors: Black
Exterior Dimensions: 40"W x 24"L (Plus 1 1/4" for handle) x 16"H
Interior Dimensions: 37 3/4"W x 23 9/16"L x 13 1/4"H (Less 1 9/16" at center for striker)
- Mounting:** Mounts to the floor of the vehicle. Mounting kit may be required for specific vehicles, sold separately.

Dividers: Dividers are sold individually to accommodate all applications

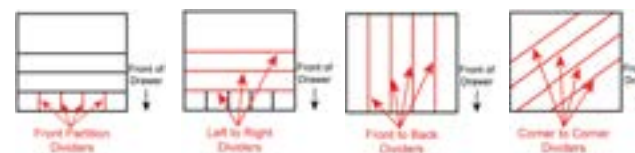

- Single Drawer**
Part# 167
- Over Under Drawers**
Part# 258
- Over Under Drawers with Vented Electronics Enclosure**
Part# 330
- Side by Side Drawers**
Part # 171
- Side by Side Drawers with a Bottom Drawer**
Part # 329
- Side by Side Drawers with a Bottom Drawer and a Vented Electronics Enclosure**
Part # 328



Visit tuffypproducts.com for vehicle fitment and a complete list of optional accessories. Custom sizes are available. Single drawers, side by side drawers or stacked drawers of varying sizes are all available configurations. Please call for pricing, options and manufacturing/delivery time. For a quote on a custom size, give us a call at 800.348.8339.

TUFFY TACTICAL SECURITY LOCKBOX

3 SIZES TO CHOOSE FROM: SLIM-LINE - #301; STANDARD - #253 & LARGE SIZE - #278.



Custom sizes and hinge orientations available. Minimum order quantity required on custom configurations. Call 800.348.8339 for more information.

Portable, convenient & secure. Tuffy's Tactical Security Lockboxes fit in any vehicle or location with sufficient space. The universal design originally created for law enforcement tactical personnel is now available for fleets, the avid sportsmen and anyone looking for solid portable security for firearms and other valuables.

Tuffy Security Product's Tactical Security Lock-Box is state of the art in secure gear storage and organization. They are designed to be secured to the vehicle by a cable which is also secured to the Tuffy lock-box with an innovative cable-lock system (*Patent rights reserved*). The unique cable locking system does not require a separate padlock and can be released in seconds to transfer the lock-box between vehicles. There are secure cable anchor points located on both sides of the lock-box so they will fit on either side of a trunk.

These highly functional and highly secure units are precision crafted from welded 16-gauge steel in the USA. The large lid opens to access a large storage space designed to accommodate an 870 shotgun, M-4 rifle and officer body armor completely outfitted.

They can be securely locked with Tuffy's exclusive locking system to provide protection for tactical equipment and other valuables. Each drawer features Tuffy's patented Pry-Guard II locking system which incorporates a 1/4" thick steel security latch. Unlike other cabinet type lock-boxes on the market that use retrofitted cabinet or house locks, the Tuffy drawer incorporates a patented pushbutton latching mechanism similar to typical OEM automotive door latches. A gas strut supports the lid open for easy access to the contents. The inside bottom and sides are lined with carpet to cushion items placed inside. Tuffy's lock-boxes can be keyed alike with a highly secure 10 Tumbler double bit key.

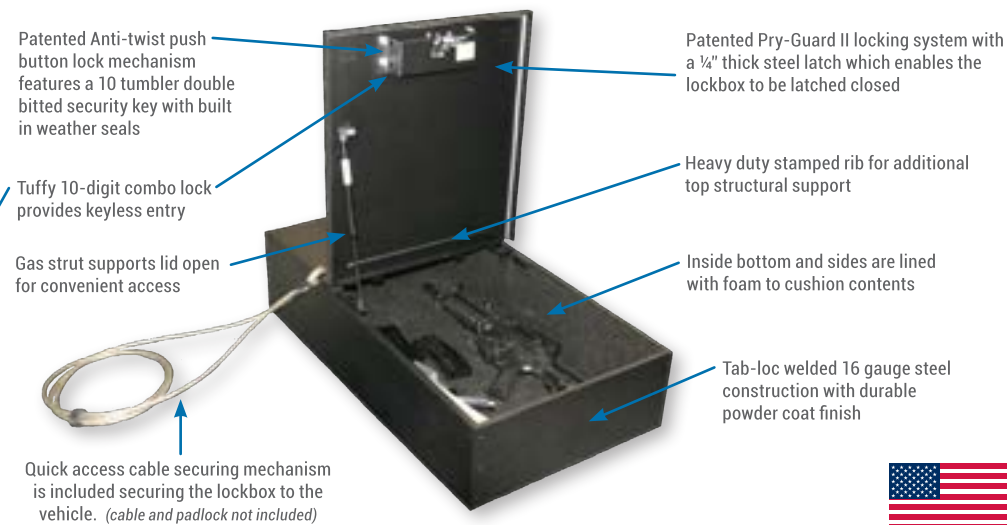

Patented Anti-twist push button lock mechanism features a 10 tumbler double bit security key.

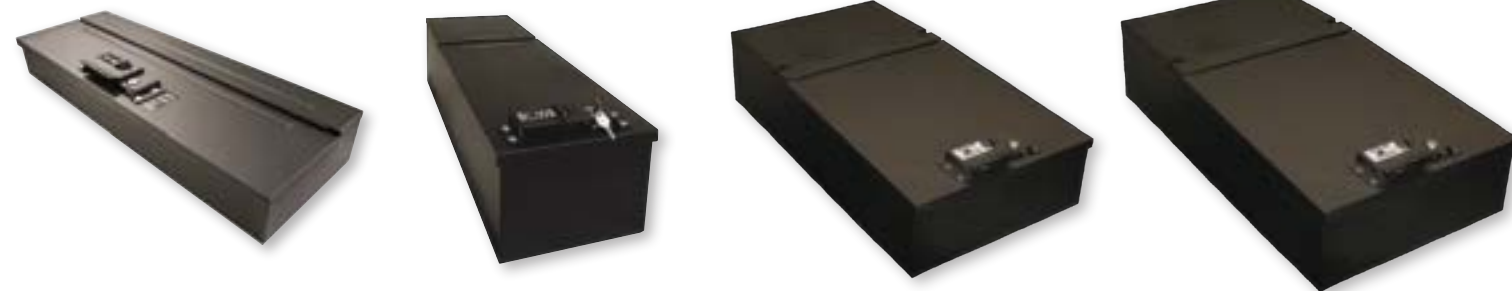

CUSTOM SIZES AVAILABLE

Scalable to your specifications
Long and Short Hinge Options
Foam and Carpet lining available
Keyless Entry
Part #: 327
Colors: Black - 01
Minimum Order Quantity Required

SLIMLINE SIZE

Part #301: Colors: Black - 01
Exterior Dimensions Overall: 40" L x 12" W x 9" H (10.25" H including combo lock above exterior lid surface)
Interior Storage Dimensions: 39 5/8" L x 11 3/8" W x 9" H.
Foam Installed In Storage Area (Low-Density): 3/8" Thick.

STANDARD SIZE

Part #253 Color: Black - 01
Exterior Dimensions: 19 7/8" W x 35 7/8" L x 8 15/16" H
Interior Dimensions: 19 1/4" W x 35 7/16" L x 5 3/8" (front) - 7 1/16" H (back)

LARGE SIZE

Part #278 Color: Black - 01
Exterior Dimensions: 22 7/8" W x 38 7/8" L x 11 7/8" H
Interior Dimensions: 22 1/4" W x 38 7/16" L x 8 5/16" (front) - 10 3/8" H (back)

Mounting: Mounts with cable and/or padlock. (Cable and padlock not included.) **Optional Accessories for Parts 253 and 278:** 886 - High Security Chain & Sleeve, 5'6". **Optional Accessories for all parts:** 879 - Looped End Security Cable. **Fits:** Any vehicle with sufficient space. Also, check to make sure the lid will clear when opened.

TABLET SAFE



Weighing less than 7 lbs., this lockable welded steel storage box is designed to secure a tablet or firearm and protect valuables while carrying by hand between locations, during travel, inside a vehicle, home or office.

Convenient pre-drilled holes allow for easy mounting to solid surfaces including airline cockpits, fleet & service vehicles, home or office environments. Access ports are built in to accommodate power and data transfer cables.

Exclusive hinge stop design prevents lid from dropping open when mounted to a solid surface and can be quickly removed to open the lid fully when on the go.

Keyless entry is provided by Tuffy's 3 digit combination lock with a two-point steel cam for added security.

The included 2 ft. long, 2000 pound test, steel security cable secures the safe to any sturdy mounting surface by attaching to the 1/8" steel security cable anchor point.

The inside is lined with low-density foam to protect the contents, while compression bumpers keep the lid vibration-free when closed.

Part #318 Color: Black - 01

Exterior Dimensions Overall: 14 1/8" L x 10 5/8" W x 1 3/4" H (2.5" H including combo lock above exterior lid surface)

Interior Storage Dimensions: 13" L x 8" W x 1" H.

Foam Installed In Storage Area (Low-Density): Lid: 3/4" Thick, Sides and Bottom: 3/8" Thick.

Lightweight: Weighs Less Than 7 Lbs. (empty without cable)

Mounting: Secures to any structural mounting area with a circumference less than 2 Ft or to any flat surface using pre-drilled holes for vehicle, airplane cabin or wall mount (using customer provided hardware).

FITS:

Designed to accommodate most 10" tablets; Ipad Air, Galaxy Tab S 10.5, Google Nexus 9, and larger devices like the Microsoft Surface, and 11" Macbook Air. Any vehicle with sufficient space or structural mounting surface inside a home, shop or office.

TUFFY PORTABLE SAFE



2 SIZES TO CHOOSE FROM: STANDARD - #300 & LARGE - #303



Tuffy 3-digit combo lock provides keyless entry

This lightweight, portable and lockable welded steel storage box can be used to secure a firearm and protect valuables while carrying it by hand between locations, during travel, inside a vehicle, home or office.

Keyless entry is provided by Tuffy's 3 digit combination lock with a two-point steel cam for added security. The included 2 ft. long, 2000 pound test, steel security cable secures the safe to any sturdy mounting surface by attaching to the 1/8" steel security cable anchor point. The inside is lined with low-density foam to protect the contents, while compression bumpers keep the lid vibration-free when closed.

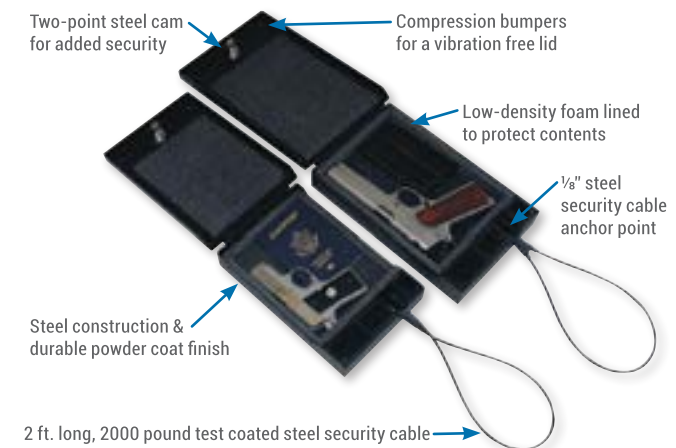

STANDARD SAFE

Part #300: Color: Black - 01
Exterior Dimensions Overall: 9 3/4" L x 6 1/2" W x 1 1/2" H (2.5" H including combo lock above exterior lid surface)
Interior Storage Dimensions (Without Foam Liner): 7 3/4" L x 6 1/8" W x 1 3/4" H.
Foam Thickness Installed Inside (Low-Density): Lid: 3/4", Sides and Bottom: 3/8".
Lightweight: Weighs Less Than 3 Lbs. (empty without cable)

Mounting: Secures To Any Structural Mounting Area with A Circumference Less Than 2 Ft. **Fits:** Anywhere with sufficient space or any structural mounting surface.

LARGE SAFE

Part #303 Color: Black - 01
Exterior Dimensions Overall: 11 3/8" L x 7 1/4" W x 1 1/2" H (2.5" H including combo lock above exterior lid surface)
Interior Storage Dimensions (Without Foam Liner): 9 1/4" L x 6 7/8" W x 1 3/4" H.
Foam Thickness Installed Inside (Low-Density): Lid, Sides and Bottom: 3/8".
Lightweight: Weighs Less Than 4 Lbs. (empty without cable)

LAPTOP COMPUTER SECURITY LOCK BOX



In 2008, the number of reported laptop thefts rose 48% over 2007. The Tuffy Laptop lock box is designed to provide a secure and protected place to lock up portable computers. The foam lining protects the contents from jarring and shifting during transport. Tuffy's exclusive Pry-Guard locking system provides the high security required to protect expensive computer equipment.

For maximum flexibility and ease of installation the lock box can be secured to the vehicle by utilizing the unique padlock mounting point to secure it to the vehicle using a standard cable. (Padlock & cable not included) The lid is still locked with the cam lock on top not the padlock.

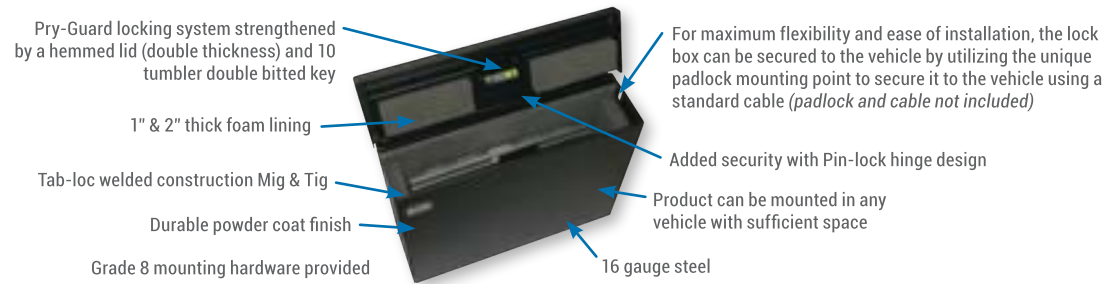

Part #182: Colors: Black - 01

Exterior Dimensions: 5¼"L x 18 5⁄₁₆"W x 14¼"H

Interior Dimensions: 2 3⁄₁₆"L x 15 3⁄₄"W x 11½"H

Mounting: No drilling required if padlock and cable are used. Standard hardware mounting requires drilling holes and securing with the fasteners provided

OPTIONAL ACCESSORIES: 090 Finger Pull Lever | 091 Lock Dust Cover | 089 Combination Lock | 879 Looped End Security Cable

FITS:

Product can be mounted to any vehicle with sufficient space. Fits most standard size laptops and these special heavy duty laptops: Toshiba - Satellite A355D, L350-ST3720
Dell - Fully Rugged
Toughbook PDRC 19, 30, F8
Check laptop size before ordering.



COMPACT SECURITY LOCKBOX



This 16 gauge steel storage box features the Pry-Guard Locking System and mounts anywhere there is available space. The Compact Security Lockbox is ideal for a CD Changer, tools, etc.

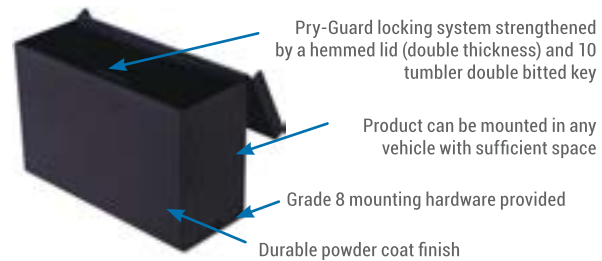

Part #029: Colors: Black - 01

Exterior Dimensions: 6¼"L x 15 3⁄₄"W x 10 1⁄₈"H

Interior Dimensions: 5 3⁄₄"L x 15 1⁄₈"W x 9 3⁄₄"H

Mounting: Mounts in any vehicle with sufficient mounting space, drilling required.

Optional Accessories: 090 Finger Pull Lever | 091 Lock Dust Cover | 089 Combination Lock | 099 Interior Light | 870 Auto On/Off Light

FITS:

Any vehicle with sufficient space



UNIVERSAL SECURITY LOCKBOX

The 16 gauge steel storage box mounts under the hood in a Jeep utilizing the space on the wheel well.



Part #027: Colors: Black - 01

Exterior Dimensions: 15½"L x (Width is tapered)

8¼"W (rear), 4"W (front) x 4 3⁄₄"H

Interior Dimensions: 14 7⁄₈"L x (Width is tapered)

7 7⁄₈"W (rear), 3 1⁄₂"W (front) x 4 1⁄₂"H

Mounting: Mounts through wheel well, drilling required (mounts in the space where the OEM jack mounts in a YJ)

Optional Accessories: 091 Lock Dust Cover | 090 Finger Pull Lever

FITS:

Wrangler YJ '87 - '95
CJ-7 '76 - '86
CJ-5 up to '83

ACCESSORIES FOR TUFFY PRODUCTS

ONE KEY TO LOCK THEM ALL. HOW DOES THIS WORK?

All Tuffy Products come with keys unless otherwise noted in the description. (e.g. you bought a combo lock upgrade or the product doesn't have a lock at all). For instance, you're buying two (2) new Tuffy Products that have keys and you want one key to lock them all. Add (1) 088-005 Flat Rate Key Alike Service to your order. Confused? Call 800.348.8339 for a quick clarification or we'll be calling you after you order to say, "Hey, you ordered too many key alike."

Key Alike Install Service - Part #088-005

REPLACEMENT PUSH BUTTON LOCK

Tuffy products can be keyed alike by purchasing additional matching locks. Additional keys are also available in pairs (part #100)

Part #102 (keys included)

REPLACEMENT CAM LOCK

Tuffy products can be keyed alike by purchasing additional matching locks. Additional keys are also available in pairs (part #100)

Part #101 (keys included)

LOCK DUST COVER

This lock cylinder dust cover is a spring loaded, plated, lock cover for Cam locks to keep water, dust, etc. out of the lock. Mounts under lock.

Part #091

COMBINATION 3-DIGIT CAM LOCK

Ideal when key entry is not desired.

Part #082: Color: 01 **Head Dimensions:** 1½" Dia x 5⁄₈" H

Mounting: Remove cam lock and fasten with hardware provided

Fits: Hole for #101 cam lock and has sufficient head space. Does NOT replace push button locks.

FINGER PULL LEVER FOR PUSH BUTTON

The steel finger pull lever is zinc plated and provides a small handle for opening and closing lids. Mounts under push button lock #102

Part #080

FINGER PULL LEVER FOR CAM LOCK

The steel finger pull lever provides a small handle for opening and closing lids. Mounts under cam lock #101

Part #090

AUTO ON/OFF LED LIGHT



The LED lamps provide intense light to find items inside enclosed dark areas. The unique automatic on/off capability eliminates accidentally running the battery down or burning out the bulb when the light is accidentally left on. Powered by AA batteries.

Part #870: Color: Black - 01

Exterior Dimensions: 4"L x 3 1⁄₂"W x 7⁄₈"H
requires three AA batteries (not included)

TUFFY 12V POWER SOURCE OUTLET



This power source outlet is rated to 12 volts 15 amps. The outlet can also be mounted to any flat surface. It features a hinging weather resistant dust cover, mounting hardware, wire, fuse, fuse holder, terminals, and connectors required for standard installations. Cigarette lighter type plug.

Part #862

Dimensions: 2 5⁄₁₆"W x 1 5⁄₈"T x 2 1⁄₂" Deep

Mounting: Drilling required in mounting surface electrical skills for hookup are required.

Fits: Mounts to any solid surface with clearance.

TUFFY 7 1⁄₂" CONSOLE GAS SPRING KIT



This gas spring kit can be mounted on Tuffy consoles with a standard hinge configuration. The 40# rated gas strut supports the lid open. The kit includes mounting brackets, ball studs, and fasteners. **Part #863**

Gas Strut: 7 1⁄₂" center to center extended, 2" stroke.

Mounting: Drilling required in mounting surface. Measurements provided are for typical 90° opening limit. Hole locations will need to be adjusted for other desired angles.

Fits: Any Tuffy console with a standard hinging design.

STANDARD DRINK HOLDER

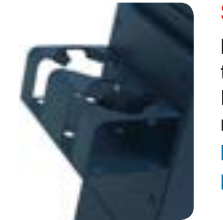

Mounts to any flat surface. Great for heavy equipment, tractors, or add to the back of any Deluxe Stereo or Series II Console (holes are pre-drilled). Mounting hardware and rubber drink fingers to reduce vibration are included.

Part #034: Colors: 01, 02, 03, 04, 05

Dimensions: 4 1⁄₂"L x 7 7⁄₈"W x 3"H
3 1⁄₂" holes for drinks

9 DEGREE REAR DRINK HOLDER



Mounts to a sloped surface. Add this extra drink holder onto the back of any Tuffy TJ Console. Hardware and rubber drink finger to reduce vibration are included.

Part #070: Colors: 01, 02, 03, 04, 05

Dimensions: 4 1⁄₂"L x 7 7⁄₈"W x 3"H
3 1⁄₂" holes for drinks

ACCESSORIES FOR TUFFY PRODUCTS



LOOPED END SECURITY CABLE

This cable is great for securing products like our Tactical Gear Lock box (#253) and Laptop Security Lock box (#182) to vehicles. It allows for easy installation and removal of these products for users with multiple vehicles.

Part #879

Dimensions: 6' Long, 3/8" or 10mm diameter



HIGH SECURITY CHAIN & SLEEVE

This chain is great for securing the Tactical Gear Lock Boxes to vehicles. Its links are 10mm thick and offer superior resistance to cutting. The sleeve offers protection and noise suppression.

Part #866 Dimensions: 5'6" Long



ANCHOR RAIL

The anchor rail is constructed from high strength aluminum and available in 24" and 48" lengths. The anchor rings are easily positioned with a work load limit of 1,333 lbs. Anchor rings and mounting hardware sold separately.

Part #882-12-07 12"L

Part #882-24-07 24"L

Part #882-48-07 48"L



ANCHOR POINT RING

The anchor point ring is designed to be used with part #882. The anchor rings are easily positioned and extremely strong with a work load limit of 1,333 lbs. Anchor rails and mounting hardware sold separately.

Part #883



ANCHOR POINT TIE DOWN KIT

This kit includes (4) 2" bases, (4) anchor point rings, and all the required hardware. The anchor rings are extremely strong with an assembly break strength of 4000 lbs and work load limit of 1,333 lbs. **Part #884**



TUFFY MODULAR GEAR ANCHORS

These gear anchors are a great way to secure loose items such as a cooler or fridge, camping gear, and outdoor recreation equipment. Drilling required. Fastens with the provided hardware.

Part #159 (set of 4)

Dimensions: 4" L x 1 1/2" W x 2 1/2" H



TUFFY MULTI-POINT TIE DOWN RAILS

These tie down rails are a great way to secure large items. **Part #158** (set of 2)

Dimensions: 27 1/4" L x 1 1/2" W x 2 1/2" H

Mounting: Drilling required. Fastens with the provided hardware.



STEREO DASH CUTOUT TRAY

After pulling the stereo out to reinstall it in a secure Tuffy console, cover the leftover hole in the dash with a functional organization tray. Powder coated steel construction, no drilling, just push the tray in and bend the retaining tabs to fasten it in the dash.

Part #150-01

Dash Cutout Size: Standard DIN, 7 1/4" x 2 1/8" (+/- 1/16")
Outside front lip 7 3/8"W x 2 5/16"H

Interior Dimensions: 6 3/4" W x 2"D (1 1/2" behind lip) x 1 3/4"H (with lip in front, opening size is 1 1/2"H)



STEREO DASH CUTOUT COVER

Cover the empty hole left in the dash after a stereo is removed with this cover. The plate can additionally be drilled for mounting switching (lights, lockers, air, etc.). Powder coated steel face plate and back tension plate. No drilling, just insert and tighten with the supplied fasteners.

Part #151-01

Dash Cutout Size: Standard DIN, 7 1/4" x 2 1/8" (+/- 1/16")
Interior Dimensions: 7 5/16"W x 2 5/16"H

COMMERCIAL GRADE DIAMOND PLATE VINYL

Weather resistant commercial grade 5/32" thick diamond plate vinyl matting. Can be used for covering the top of drawers and lining the inside of Tuffy boxes.

Part #864-036 Color: 01 Black

Sold per 3'W linear foot cut to any length per foot

Part #864-048 Color: 01 Black

Sold per 4'W linear foot cut to any length per foot

Mounting: Cut to size and affix it to surface using spray adhesive part #861

Accessories: Part #861, Hi-Temp adhesive



CARPET FOR LINING BOXES

Weather resistant marine grade carpet lining. Sold per 6'W linear foot cut to any length per foot. (6'W x 1' increments)

Part #860 Color: 01 Black



HI-TEMP ADHESIVE

Hi-Temp adhesive for carpet, etc. 1 can per 32 sq. ft. recommended.

Part #861, 13 oz. Spray Can



TUFFY KOKOPELLI BOTTLE OPENER

A must have for those discerning Jeepers. The strongest bottle opener, made with 1/8" steel and a rubber grip.

Part #856

VALUED CUSTOMER

Tuffy is constantly developing new and exciting storage solutions. For products and product enhancements that have recently come available for your vehicle and are not in this catalog version please visit our website at tuffyproducts.com. If you don't see the product application you are looking for or have a suggestion please e-mail us at: sales@tuffyproducts.com. We also manufacture a wide range of custom boxes not shown in the catalog or website for government, industrial, fleet, and highly specialized applications. Tuffy values your opinion. Thank you for choosing Tuffy as your storage solution provider.

AWARDS TUFFY HAS RECEIVED

FOUR WHEELER MAGAZINE - 1996 READER ALL STAR POLL

All Star Manufacturers: Tuffy Security Products

Typical comment: "Very easy to deal with, and a very good product" Los Alamos, NM

All Star Parts: Tuffy's stereo security console.

1992 ENTREPRENEUR OF THE YEAR AWARD RECIPIENT

Awarded to Tuffy Security Products - Sponsored by Inc. Magazine, Merrill Lynch and Ernst & Young.

2011 HUBZONE CONTRACTOR OF THE YEAR

WHAT DO TOP MAGAZINES SAY ABOUT TUFFY?

Four Wheeler

"...some steel can really help, Tuffy Security Products makes a very secure box that suited our need perfectly" and "reported to provide significant deterrence to even the most determined thief."

4 Wheel Drive & Sport Utility

During the building of Project Too Long "...first up was a weather proof console from Tuffy Security Products. Not only is the roomy Tuffy console sealed against dust and moisture, it also offers protection from the two-legged, ten-fingered opportunists who prey on unlockable Jeep interiors." and "Tuffy's products not only secure your articles, they dress up the interior of any 4x4."

Petersen's 4 Wheel & Off-Road

"Tuff Stuff" and "Really Tuff."

JP

"High Security" and "Lock it good."

Off Road

"Serious theft protection, highest quality boxes available."

Sport Truck

"Get more security for your Jeep or truck with a Convenience Console from Tuffy Security Products."

Truck 'N' Trail

"The high security consoles produced by Tuffy Security Products make it Tuff for thieves."

Hunting

"High Security Storage Lockers" says it all.

A FEW COMMENTS FROM TUFFY CUSTOMERS

I can proudly say, "The engineers at Tuffy have not only designed a glove box which is Baltimore Street Thug proof; the box is also lazy owner proof."

Baltimore, MD

I am impressed by the quality, professionalism and efficiency of the customer service that you provided. I am grateful and appreciative to you for your commitment to putting the customer first and treating the customer how you would want to be treated. Your response is a testament of how all businesses should respond to their customers; and you, Tuffy Security Products, should be proud of your work ethic and dedication. I will highly recommend Tuffy Security Products to others and I will continue to use your products.

Connecticut State Police, Hartford, CT

"After I mounted my Tuffy console, my Jeep was broken into. The thieves took everything but what was safely locked in my Tuffy console. Good thing I had it, Tuffy saved me a lot of money."

Littleton, CO

"It leaves me feeling secure about leaving my Jeep unattended knowing my stereo equipment it safe and secure. This console is definitely top quality. Also a very attractive addition to my custom interior."

Brigantine, NJ

"..It works super and is really valuable to me. Before I had the console, I had two stereos stolen in a two month span. I really must compliment your console."

Virginia Beach, VA

"Installation was a breeze, and the quality is second to none! The finish and appearance is great, it looks like Detroit made it that way! It's very encouraging in these tough economic times to get so much value and quality for your money. Thank you for a terrific product!"

Hornell, NY

THE TUFFY WARRANTY

Tuffy Has One Of The Best Warranties In The Industry Because Tuffy Products Are Built To Last!

Read the full warranty online at: <https://www.tuffyproducts.com/t-warranty.aspx>



Tuffy reserves the right to change specifications and prices without prior notice. Please check local laws concerning storage of fire arms in vehicles. Tuffy's product designs are protected under patent numbers 6564602, 6964184, 7083219, 7140649, 7513541, 8256819, 8517445, 9039062 and 9079625. Tuffy has several products which are Patent Pending. Tuffy reserves patent rights on all products developed. "Tuffy Security Products" is a Registered Trademark of Tuffy Security Products, Inc., Cortez, CO. "Pry-Guard", "Pry-Guard II", "Pin-lock" and "Anti-twist" are Trademarks of Tuffy Security Products, Inc., Cortez, CO. "Jeep", "CJ", "JK", "LJ", "TJ", "YJ", "Unlimited", and "Wrangler" are registered trademarks of Chrysler Corporation and have no affiliation with Tuffy Security Products. "Samurai" is a trademark of the Suzuki Motor Corporation and has no affiliation with Tuffy Security Products. "Toyota", "Tacoma" and "Tundra" are trademarks of Toyota Motor Sales and has no affiliation with Tuffy Security Products. "Yakima" is a trademark of Yakima Products Inc. and has no affiliation with Tuffy Security Products. "Thule" is a trademark of Thule AB and has no affiliation with Tuffy Security Products. Tuffy Security Products, Inc. has no affiliation with the General Motors Corp., the Suzuki Motor Corp., Ford Motor Company, FCA Chrysler or Toyota Motor Sales. Copyright © 2017, Tuffy Security Products. All Rights Reserved.



SERIOUS THEFT PROTECTION

25733 ROAD H
CORTEZ, CO 81321

PHONE: 800.348.8339

LOCAL: 970.564.1762

FAX: 970.564.1783

EMAIL: INFO@TUFFYPRODUCTS.COM

You need to know that the expensive gear and supplies in your vehicle are protected but can also be at your fingertips at a moment's notice.

That's why Tuffy Security Products offers state-of-the-art secure gear organization and storage solutions that fit your needs.

GETTING YOUR GEAR STOLEN IS NO ADVENTURE

SECURE STORAGE COVER



CARGO SECURITY STORAGE



SECURE CONSOLE STORAGE



CONCEALED TRUCK UNDER SEAT STORAGE



STEEL SECURITY DRAWER



CONCEAL CARRY SECURITY



SECURITY GLOVE BOX



Scan this code with your smartphone to view these gear storage solutions and browse all our heavy duty products built to withstand a lifetime of abuse.

800.348.8339 | tuffyproducts.com